

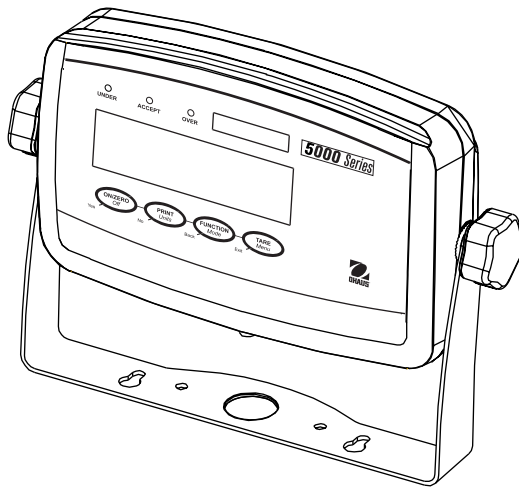

# 5000 Series Indicators

## Instruction Manual



**T51P Indicator**

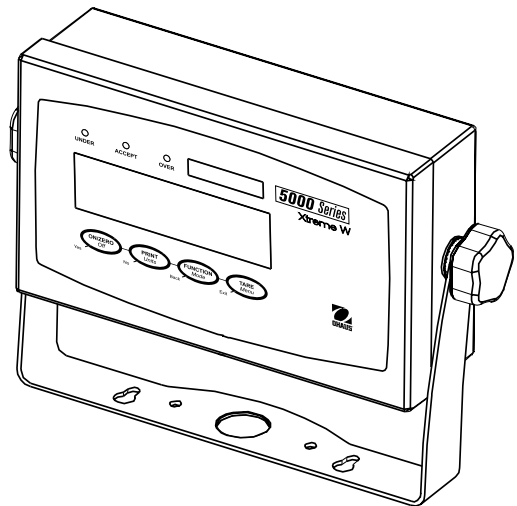

**T51XW Indicator**



## TABLE OF CONTENTS

1.	INTRODUCTION.....	EN-5
1.1	Safety Precautions .....	EN-5
1.1.1	Relay Option Safety Precautions .....	EN-5
1.2	Overview of Parts and Controls .....	EN-6
1.3	Control Functions.....	EN-10
2.	INSTALLATION .....	EN-11
2.1	Unpacking .....	EN-11
2.2	External Connections.....	EN-11
2.2.1	Scale Base with Connector to T51P .....	EN-11
2.2.2	RS232 Interface Cable to T51P.....	EN-11
2.2.3	AC Power to T51P .....	EN-11
2.2.4	AC Power to T51XW.....	EN-11
2.2.5	Battery Power to T51P.....	EN-11
2.2.6	Mounting Bracket.....	EN-12
2.3	Internal Connections.....	EN-12
2.3.1	Opening the Housing.....	EN-12
2.3.2	Scale Base Without Connector to T51P or T51XW .....	EN-12
2.3.3	RS232 Interface Cable to T51XW.....	EN-13
2.3.4	Footswitch to T51P or T51XW.....	EN-13
2.4	T51P Rear Housing Orientation .....	EN-13
2.5	Mounting Bracket.....	EN-13
3.	SETTINGS.....	EN-14
3.1	Menu Structure .....	EN-14
3.2	Menu Navigation .....	EN-15
3.3	Calibration Menu .....	EN-15
3.3.1	Zero Calibration .....	EN-16
3.3.2	Span Calibration.....	EN-16
3.3.3	Linearity Calibration .....	EN-17
3.3.4	Calibration Test .....	EN-18
3.3.5	Geographical Adjustment Factor .....	EN-18
3.3.6	End Calibration.....	EN-18
3.4	Setup Menu.....	EN-20
3.4.1	Reset.....	EN-20
3.4.2	Range .....	EN-20
3.4.3	Capacity .....	EN-20
3.4.4	Graduation.....	EN-21
3.4.5	Power On Unit .....	EN-21
3.4.6	Zero Range .....	EN-21
3.4.7	Auto-Tare.....	EN-22
3.4.8	Retain Weight Data .....	EN-22
3.4.9	Legal for Trade .....	EN-22
3.4.10	Beeper Volume .....	EN-23

### TABLE OF CONTENTS (Cont.)

3.4.11	Beeper Signal .....	EN-23
3.4.12	Button Beeper .....	EN-23
3.4.13	End Setup .....	EN-23
3.5	Readout Menu .....	EN-23
3.5.1	Reset .....	EN-24
3.5.2	Stable Range .....	EN-24
3.5.3	Filter .....	EN-24
3.5.4	Auto-Zero Tracking .....	EN-24
3.5.5	Backlight .....	EN-25
3.5.6	Auto Off Timer .....	EN-25
3.5.7	Gross Indicator .....	EN-25
3.5.8	End Readout .....	EN-25
3.6	Mode Menu .....	EN-25
3.6.1	Reset .....	EN-26
3.6.2	Weighing Mode .....	EN-26
3.6.3	Parts Counting Mode .....	EN-26
3.6.4	Parts Counting Optimize .....	EN-26
3.6.5	Percent Weighing Mode .....	EN-26
3.6.6	Dynamic Weighing Mode .....	EN-26
3.6.7	Check Weighing Mode .....	EN-27
3.6.8	End Mode .....	EN-27
3.7	Unit Menu .....	EN-27
3.7.1	Reset .....	EN-27
3.7.2	Kilogram Unit .....	EN-27
3.7.3	Pound Unit .....	EN-27
3.7.4	Gram Unit .....	EN-28
3.7.5	Ounce Unit .....	EN-28
3.7.6	Pound Ounce Unit .....	EN-28
3.7.7	Tonnes Unit .....	EN-28
3.7.8	Custom Unit .....	EN-28
3.7.9	End Unit .....	EN-29
3.8	GMP Menu .....	EN-29
3.8.1	Reset .....	EN-29
3.8.2	Date Type .....	EN-29
3.8.3	Date Set .....	EN-30
3.8.4	Time Type .....	EN-30
3.8.5	Time Set .....	EN-30
3.8.6	User ID .....	EN-31
3.8.7	Project ID .....	EN-31
3.8.8	Scale ID .....	EN-31
3.8.7	End GMP .....	EN-31
3.9	Print1 and Print2 Menus .....	EN-32
3.9.1	Reset .....	EN-32
3.9.2	Print Stable data Only .....	EN-32
3.9.3	Auto Print .....	EN-32
3.9.4	Print Content Sub-menu .....	EN-33

### TABLE OF CONTENTS (Cont.)

3.9.5	Layout Sub-menu .....	EN-35
3.9.6	Output .....	EN-35
3.9.7	List Menu Settings.....	EN-35
3.9.8	End Print1 or End Print2 .....	EN-35
3.10	COM1 and COM2 Menus .....	EN-35
3.10.1	Reset.....	EN-36
3.10.2	Baud .....	EN-36
3.10.3	Parity .....	EN-36
3.10.4	Stop Bit.....	EN-36
3.10.5	Handshake .....	EN-36
3.10.6	Address .....	EN-36
3.10.7	Alternate Command Sub-menu.....	EN-37
3.10.8	End COM1 or End COM2 .....	EN-37
3.11	I-O Menu.....	EN-37
3.11.1	Reset.....	EN-37
3.11.2	External Input .....	EN-38
3.11.3	Input Beep .....	EN-38
3.11.4	Relay Output .....	EN-38
3.11.5	End I-O.....	EN-39
3.12	Menu Lock Menu .....	EN-39
3.12.1	Reset.....	EN-39
3.12.2	Lock Calibration .....	EN-39
3.12.3	Lock Setup .....	EN-40
3.12.4	Lock Readout .....	EN-40
3.12.5	Lock Mode.....	EN-40
3.12.6	Lock Unit .....	EN-40
3.12.7	Lock Print1 .....	EN-40
3.12.8	Lock Print2 .....	EN-40
3.12.9	Lock COM1 .....	EN-40
3.12.10	Lock COM2 .....	EN-40
3.12.11	Lock GMP .....	EN-41
3.12.12	Lock I-O.....	EN-41
3.12.13	End Lock .....	EN-41
3.13	Key Lock Menu.....	EN-41
3.13.1	Reset.....	EN-41
3.13.2	Lock All Buttons.....	EN-41
3.13.3	Lock Off Button .....	EN-41
3.13.4	Lock Zero Button.....	EN-41
3.13.5	Lock Print Button .....	EN-42
3.13.6	Lock Unit Button .....	EN-42
3.13.7	Lock Function Button.....	EN-42
3.13.8	Lock Mode Button .....	EN-42
3.13.9	Lock Tare Button.....	EN-42
3.13.10	Lock Menu Button .....	EN-42
3.13.11	End Lock .....	EN-42
3.14	Security Switch .....	EN-42

**TABLE OF CONTENTS (Cont.)**

4. OPERATION.....	EN-43
4.1 Turning Indicator On/Off.....	EN-43
4.2 Zero Operation.....	EN-43
4.3 Manual Tare.....	EN-43
4.4 Pre-Set Tare.....	EN-43
4.5 Auto-Tare.....	EN-43
4.6 Changing Units of Measure.....	EN-44
4.7 Printing Data.....	EN-44
4.8 Application Modes.....	EN-44
4.8.1 Weighing.....	EN-44
4.8.2 Parts Counting.....	EN-44
4.8.3 Percent Weighing.....	EN-45
4.8.4 Check Weighing.....	EN-46
4.8.5 Dynamic Weighing.....	EN-47
5. SERIAL COMMUNICATION.....	EN-48
5.1 Interface Commands.....	EN-48
5.2 Output Format.....	EN-49
5.3 Printouts.....	EN-49
6. LEGAL FOR TRADE.....	EN-51
6.1 Settings.....	EN-51
6.2 Verification.....	EN-51
6.3 Sealing.....	EN-51
7. MAINTENANCE.....	EN-53
7.1 Model T51P Cleaning.....	EN-53
7.2 Model T51XW Cleaning.....	EN-53
7.3 Troubleshooting.....	EN-53
7.4 Service Information.....	EN-54
8. TECHNICAL DATA.....	EN-55
8.1 Specifications.....	EN-55
8.2 Accessories and Options.....	EN-56
8.3 Drawings and Dimensions.....	EN-57
8.4 Compliance.....	EN-58

## 1. INTRODUCTION

This manual contains installation, operation and maintenance instructions for the T51P and T51XW Indicators. Please read this manual completely before installation and operation.

### 1.1 Safety Precautions



For safe and dependable operation of this equipment, please comply with the following safety precautions:

- Verify that the input voltage range printed on the data label matches the local AC power to be used.
- Make sure that the power cord does not pose a potential obstacle or tripping hazard.
- Use only approved accessories and peripherals.
- Operate the equipment only under ambient conditions specified in these instructions.
- Disconnect the equipment from the power supply when cleaning.
- Do not operate the equipment in hazardous or unstable environments.
- Do not immerse the equipment in water or other liquids.
- Service should only be performed by authorized personnel.
- The T51XW is supplied with a grounded power cable. Use only with a compatible grounded power outlet.

#### 1.1.1 Relay Option Safety Precautions

This equipment may have an optional AC or DC Relay Option board installed. This option allows external devices to be controlled by the Indicator.



**CAUTION: ELECTRICAL SHOCK HAZARD. REMOVE ALL POWER CONNECTIONS TO THE INDICATOR BEFORE SERVICING OR MAKING INTERNAL CONNECTIONS. THE HOUSING SHOULD ONLY BE OPENED BY AUTHORIZED AND QUALIFIED PERSONNEL, SUCH AS AN ELECTRICAL TECHNICIAN.**

Before making connections to the Relay terminals, remove power from the system. If the system contains an optional rechargeable battery system, be sure that the **ON/ZERO Off** button is used to fully turn off the system after removing the AC power plug.

More detailed installation instructions are included with the Relay Option Kit when purchased.

1.2 Overview of Parts and Controls

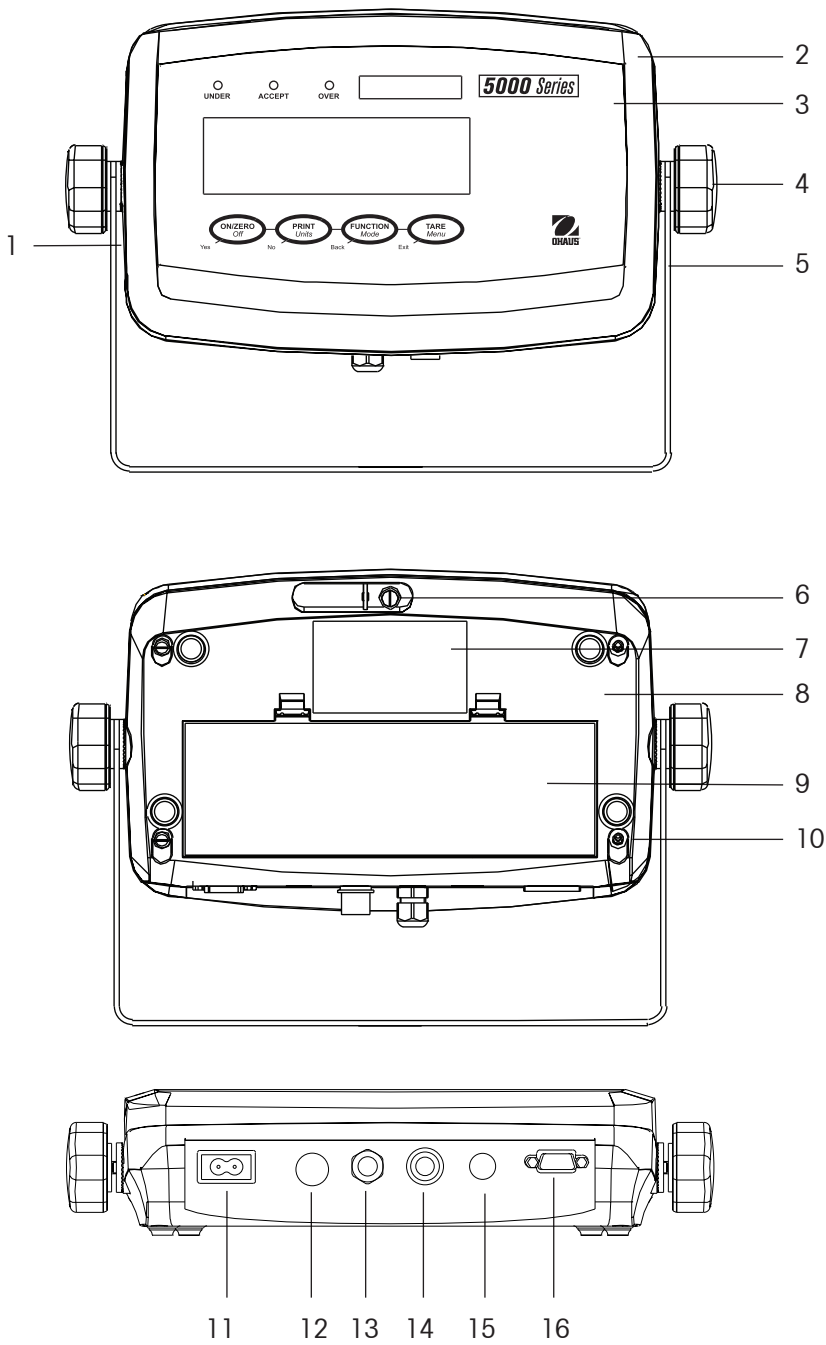

TABLE 1-1. T51P PARTS.

Item	Description
1	Data Label
2	Front Housing
3	Control Panel
4	Adjusting Knob (2)
5	Mounting Bracket
6	Security Screw
7	Data Label
8	Rear Housing
9	Battery Cover
10	Screw (4)
11	Power Receptacle
12	Hole plug for option
13	Strain relief for alternate load cell connection
14	Load Cell Connector
15	Hole plug for option
16	RS232 Connector

Figure 1-1. T51P Indicator.



1.2 Overview of Parts and Controls (Cont.)

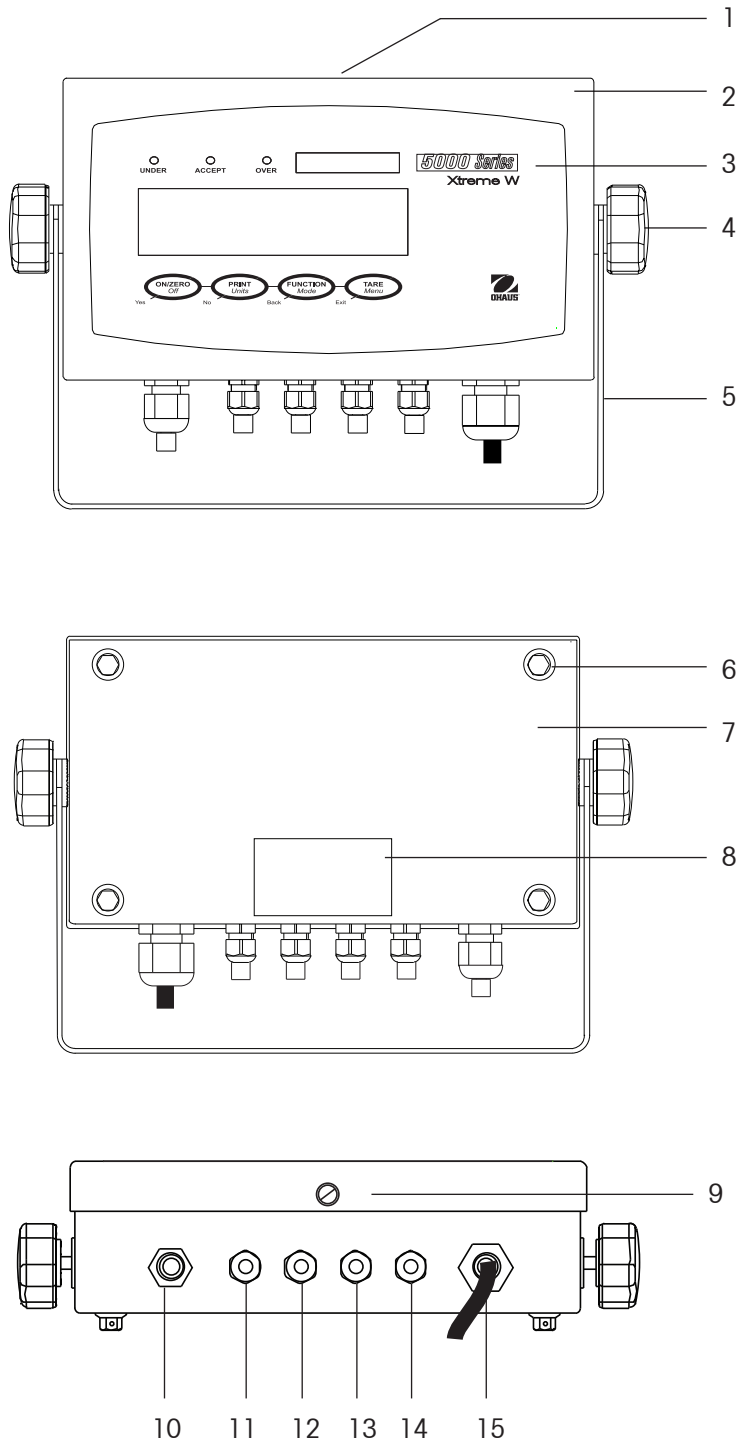

TABLE 1-2. T51XW PARTS.

Item	Description
1	Data Label
2	Front Housing
3	Control Panel
4	Adjusting Knob (2)
5	Mounting Bracket
6	Screw (4)
7	Rear housing
8	Data Label
9	Security Screw
10	Strain relief for option
11	Strain relief for RS232
12	Strain relief for option
13	Strain relief for option
14	Strain relief for Load Cell Cable
15	Power cord

Figure 1-2. T51XW Indicator.

1.2 Overview of Parts and Controls (Cont.)

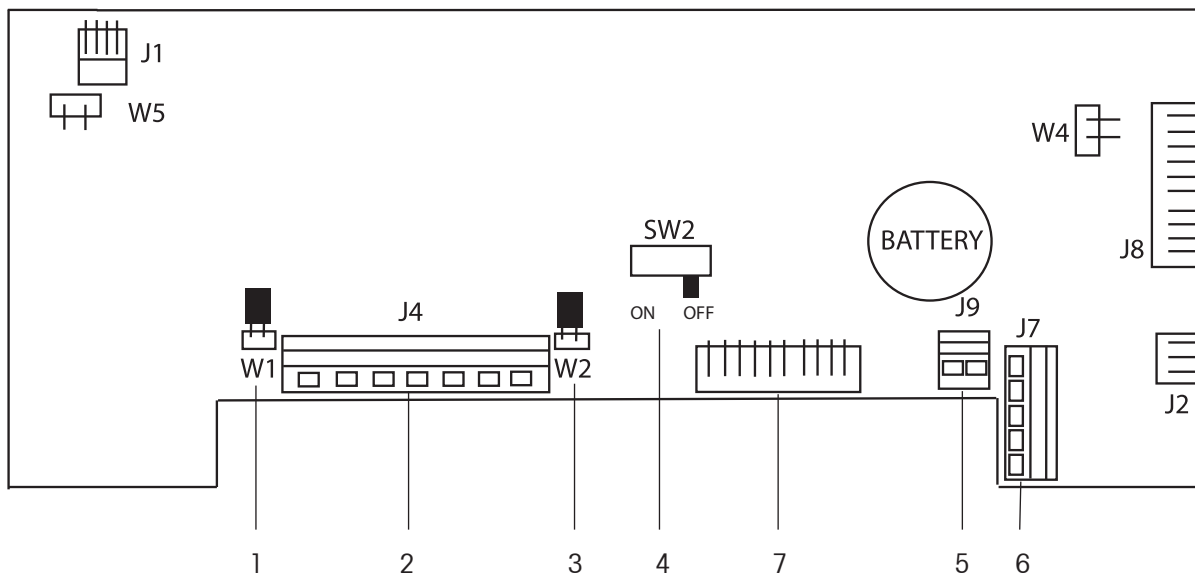

Figure 1-3. Main PC Board.

**TABLE 1-3. MAIN PC BOARD.**

Item	Description
1	Sense Jumper W1
2	Alternate Load Cell Terminal Block J4
3	Sense Jumper W2
4	Security Switch SW2
5	External input Terminal Block J9
6	RS232 Terminal Block J7 (T51XW only)
7	Load Cell Connector (T51P only)

1.2 Overview of Parts and Controls (Cont.)

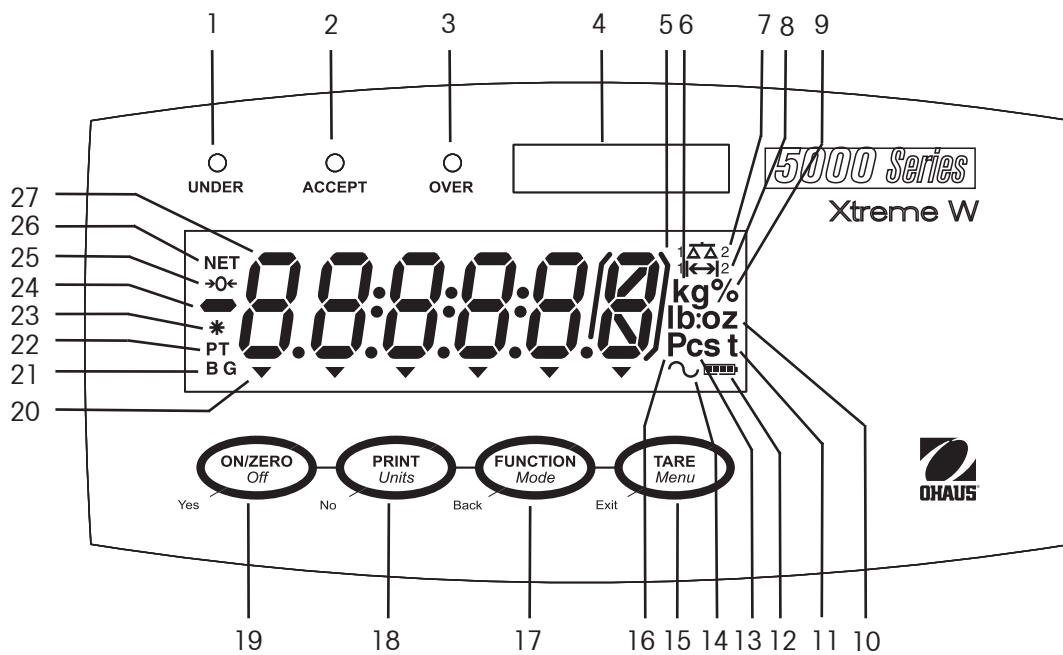





Figure 1-4. Controls and Indicators.

TABLE 1-4. CONTROL PANEL.

No.	Designation	No.	Designation
1	UNDER LED	15	TARE <i>Menu</i> button
2	ACCEPT LED	16	Pieces symbol
3	OVER LED	17	FUNCTION <i>Mode</i> button
4	Capacity Label Window	18	PRINT <i>Units</i> button
5	Brackets (not used)	19	ON/ZERO <i>Off</i> button
6	Kilogram, gram symbols	20	Pointer symbols (not used)
7	Scale symbol (not used)	21	Brutto, Gross symbols
8	Range symbol	22	Preset Tare, Tare symbols
9	Percent symbol	23	Stable weight Indicator
10	Pound, Ounce, Pound:ounce symbols	24	Negative symbol
11	Tonne symbol	25	Center of Zero Indicator
12	Battery charge symbol	26	NET symbol
13	Custom unit symbol	27	7-segment Display
14	Dynamic symbol		

1.3 Control Functions

TABLE 1-5. CONTROL FUNCTIONS.

Button	 Yes	 No	 Back	 Exit
Primary Function (Short Press)	<p><b>ON/ZERO</b> Turns the Indicator on.</p> <p>If Indicator is On, sets zero.</p>	<p><b>PRINT</b> Sends the current value to the selected COM ports if AUTOPRINT is set to Off.</p>	<p><b>FUNCTION</b> Initiates an application mode.</p> <p>Temporarily displays the active mode's reference data.</p> <p>In Weigh mode, temporarily displays 10x expanded resolution.</p>	<p><b>TARE</b> Performs a tare operation.</p>
Secondary Function (Long Press)	<p><b>Off</b> Turns the Indicator off.</p>	<p><b>Units</b> Changes the weighing Unit.</p>	<p><b>Mode</b> Allows changing the application mode.</p> <p>Press and hold allows scrolling through modes.</p>	<p><b>Menu</b> Enter the User menu.</p>
Menu Function (Short Press)	<p><b>Yes</b> Accepts the current setting on the display.</p>	<p><b>No</b> Advances to the next menu or menu item.</p> <p>Rejects the current setting on the display and advances to the next available setting.</p> <p>Increments the value.</p>	<p><b>Back</b> Moves Back to previous menu item.</p> <p>Decrements the value.</p>	<p><b>Exit</b> Exits the User menu.</p> <p>Aborts the calibration in progress.</p>

## 2. INSTALLATION

### 2.1 Unpacking

Unpack the following items:

- T51P or T51XW Indicator
- AC Power Cord (T51P only)
- Mounting Bracket
- Knobs (2)
- Capacity Label Sheet
- LFT Sealing kit
- Instruction Manual CD
- Warranty Card

### 2.2 External Connections

#### 2.2.1 Scale Base with Connector to T51P

Ohaus bases with a connector can be attached to the external load cell connector (Figure 1-1, item 14). Refer to section 2.3.2 for bases without a connector. To make the connection, plug the base connector onto the external load cell connector. Then rotate the base connector’s locking ring clockwise.

For connecting bases with a connector to a T51XW (which does not have the external connector), a Load Cell Cable Adapter Kit p/n 80500736 is available as an accessory. This kit connects to the terminal block inside the T51XW and has an external connector on the other end.

#### 2.2.2 RS232 interface Cable to T51P

Connect the optional RS232 cable to the RS232 connector (Figure 1-1, item 16).

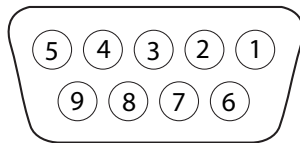

Figure 2-1. RS232 Pins.

Pin	Connection
1	N/C
2	TXD
3	RXD
4	N/C
5	GND
6	N/C
7	CTS
8	RTS
9	N/C

#### 2.2.3 AC Power to T51P

Connect the AC power cord (supplied) to the power receptacle (Figure 1-1, item 11), then connect the AC plug to an electrical outlet.

#### 2.2.4 AC Power to T51XW

Connect the AC plug to a properly grounded electrical outlet.

#### 2.2.5 Battery Power to T51P

The indicator can be operated on alkaline batteries (not supplied) when AC power is not available. It will automatically switch to battery operation if there is power failure or the power cord is removed. The indicator can operate for up to 80 hours on battery power.

Remove the battery cover (Figure 1-1, item 9) and install 6 C-type (LR14) alkaline batteries in the orientation specified. Re-install the battery cover.

During battery operation, the battery charge symbol indicates the battery status.

The indicator will automatically turn-off when the batteries are fully discharged.

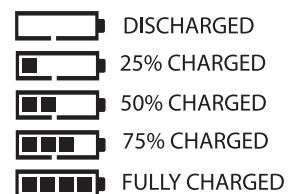

### 2.2.6 Mounting Bracket

Position the wall bracket over the threaded holes in the side of the indicator as shown in Figures 8-1 or 8-2 and install the knobs. Adjust the indicator to the desired angle and tighten the knobs.

## 2.3 Internal Connections

Some connections require the housing to be opened.

### 2.3.1 Opening the Housing



**CAUTION: ELECTRICAL SHOCK HAZARD. REMOVE ALL POWER CONNECTIONS TO THE INDICATOR BEFORE SERVICING OR MAKING INTERNAL CONNECTIONS. THE HOUSING SHOULD ONLY BE OPENED BY AUTHORIZED AND QUALIFIED PERSONNEL, SUCH AS AN ELECTRICAL TECHNICIAN.**

#### T51P

Remove the four Phillips head screws from the rear housing.  
 Remove the front housing being careful not to disturb the internal connections.  
 Once all connections are made, reattach the front housing.

#### T51XW

Remove the four hex head screws from the rear housing.  
 Open the housing by carefully pulling the front housing forward.  
 Once all connections are made, reattach the front housing.  
 The screws should be tightened to 2.5 N·m (20-25 in·lb) torque to ensure a watertight seal.

### 2.3.2 Scale Base Without Connector to T51P or T51XW

Bases without a connector must be attached to the internal load cell connector on the main PC board. Pass the load cell cable through the strain relief (Figure 1-1, item 13 or Figure 1-2, item 13) and attach it to terminal block J4 (Figure 1-3, item 2). Tighten the strain relief to maintain a watertight seal.

#### Jumper Connections

For a 4-wire load cell with no sense wires: Jumpers W1 and W2 must be left in place shorting the two pins.  
 For a 6-wire load cell that includes sense wires, Jumpers W1 and W2 must be removed.  
 For load cells with an extra ground shield wire: Connect the shield to the center position (GND) of J4.

Pin	Connection
J4-1	+EXE
J4-2	+SEN
J4-3	+SIG
J4-4	GND
J4-5	-SIG
J4-6	-SEN
J4-7	-EXE



Figure 2-2. Jumper Connections.

After wiring is completed and jumpers are in place, replace the indicator housing screws. Make sure the liquid-tight connector is properly tightened.

**2.3.3 RS232 Interface Cable to T51XW**

Pass the optional RS232 cable through the strain relief (Figure 1-2, item 10) and attach it to terminal block J7 (Figure 1-3, item 6). Tighten the strain relief to maintain a watertight seal.

Pin	Connection
J7-1	RTS
J7-2	TXD
J7-3	RXD
J7-4	CTS
J7-5	GND

**2.3.4 Footswitch to T51P or T51XW**

Pass the optional footswitch cable through the strain relief (Figure 1-1, item 15 or Figure 1-2, item 11) and attach it to terminal block J9 (Figure 1-3, item 5).

**2.4 T51P Rear Housing Orientation**

The T51P is delivered in the wall mount orientation with the connections exiting below the display. The rear housing may be reversed so the connections exit above the display when the T51P is placed horizontally on a bench. To reverse the rear housing, remove the four Phillips head screws, carefully rotate the housing 180°, and reinstall the screws.

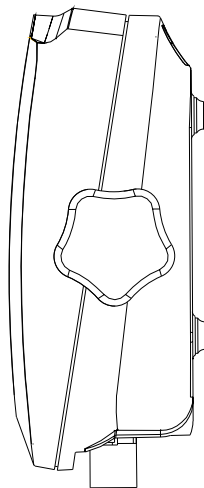

Figure 2-3. Wall Mount Configuration.

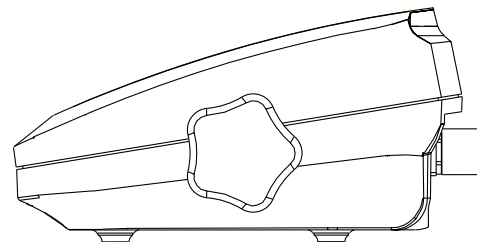

Figure 2-4. Bench Top Configuration.

**2.5 Mounting Bracket**

Attach the bracket to a wall or table using fasteners (not supplied) that are appropriate for the type of mounting surface. The bracket will accommodate up to 6 mm (1/4") diameter screws. Locate the mounting holes as shown in Figure 2-5.

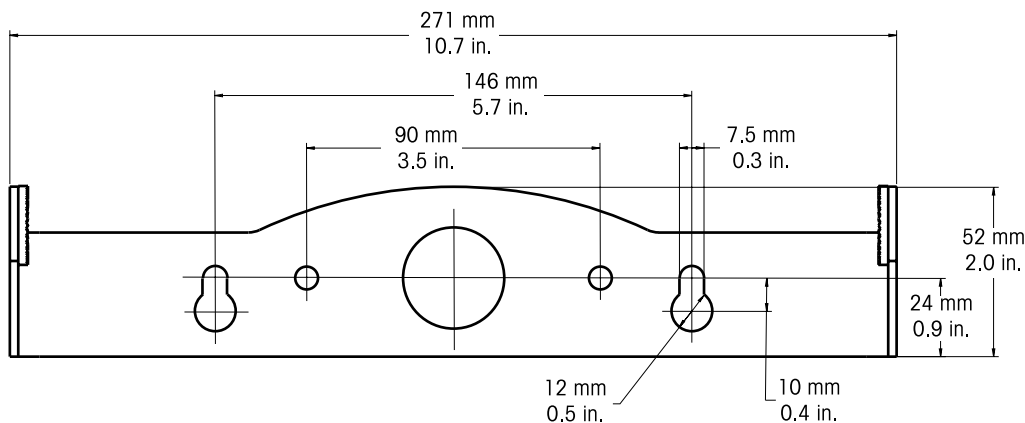

Figure 2-5 Mounting Bracket Dimensions.

### 3. SETTINGS

#### 3.1 Menu Structure

TABLE 3-1. MENU STRUCTURE.

→ <b>CALIBRATION</b> →	<b>SETUP</b> →	<b>READOUT</b> →	<b>MODE</b> →	<b>UNIT</b> →	<b>GMP</b> →	<b>PRINT1</b> →
<ul style="list-style-type: none"> <li>• ZERO <sup>1)</sup></li> <li>• SPAN <sup>1)</sup></li> <li>• LINEARITY <sup>1)</sup></li> <li>• CAL TEST</li> <li>• GEO <sup>1)</sup></li> <li>• END CAL</li> </ul>	<ul style="list-style-type: none"> <li>• RESET</li> <li>• RANGE <sup>2)</sup></li> <li>• CAPACITY <sup>2)</sup></li> <li>• GRADUATION <sup>2)</sup></li> <li>• POWER ON UNIT <sup>2)</sup></li> <li>• ZERO RANGE <sup>2)</sup></li> <li>• AUTO TARE <sup>2)</sup></li> <li>• RETAIN WEIGHT <sup>2)</sup></li> <li>• LEGAL FOR TRADE</li> <li>• BEEPER VOLUME</li> <li>• BEEPER SIGNAL</li> <li>• BUTTON BEEPER</li> <li>• END SETUP</li> </ul>	<ul style="list-style-type: none"> <li>• RESET</li> <li>• STABLE RANGE <sup>2)</sup></li> <li>• FILTER</li> <li>• AUTO ZERO <sup>2)</sup></li> <li>• BACKLIGHT</li> <li>• AUTO OFF TIMER</li> <li>• GROSS INDICATOR</li> <li>• END READOUT</li> </ul>	<ul style="list-style-type: none"> <li>• RESET</li> <li>• WEIGH <sup>2)</sup></li> <li>• COUNT <sup>2)</sup></li> <li>• PERCENT <sup>2)</sup></li> <li>• DYNAMIC <sup>2)</sup></li> <li>• CHECK WEIGH <sup>2)</sup></li> <li>• END MODE</li> </ul>	<ul style="list-style-type: none"> <li>• RESET</li> <li>• KILOGRAM <sup>2)</sup></li> <li>• POUND <sup>2)</sup></li> <li>• GRAM <sup>2)</sup></li> <li>• OUNCE <sup>2)</sup></li> <li>• POUND OUNCE <sup>2)</sup></li> <li>• TONNE <sup>2)</sup></li> <li>• CUSTOM <sup>2)</sup></li> <li>• END UNIT</li> </ul>	<ul style="list-style-type: none"> <li>• RESET</li> <li>• DATE</li> <li>• DATE TYPE</li> <li>• DATE SET</li> <li>• TIME</li> <li>• TIME TYPE</li> <li>• TIME SET</li> <li>• USER ID</li> <li>• PROJECT ID</li> <li>• SCALE ID</li> <li>• END GMP</li> </ul>	<ul style="list-style-type: none"> <li>• RESET</li> <li>• STABLE ONLY <sup>2)</sup></li> <li>• AUTO PRINT</li> <li>• CONTENT</li> <li>• RESULT</li> <li>• GROSS</li> <li>• NET</li> <li>• TARE</li> <li>• HEADER</li> <li>• USER ID</li> <li>• PROJECT ID</li> <li>• SCALE ID</li> <li>• DIFFERENCE</li> <li>• DATE TIME</li> <li>• INFO</li> <li>• MODE</li> <li>• NAME</li> <li>• LAYOUT</li> <li>• FORMAT</li> <li>• FEED</li> <li>• LIST</li> <li>• END PRINT1</li> </ul>

→ <b>PRINT2</b> →	<b>COM1</b> →	<b>COM2</b> →	<b>I-O</b> →	<b>LOCK MENU</b> →	<b>LOCK KEY</b> →	<b>END</b> →
<ul style="list-style-type: none"> <li>• RESET</li> <li>• STABLE ONLY <sup>2)</sup></li> <li>• AUTO PRINT</li> <li>• CONTENT</li> <li>• RESULT</li> <li>• GROSS</li> <li>• NET</li> <li>• TARE</li> <li>• HEADER</li> <li>• USER ID</li> <li>• PROJECT ID</li> <li>• SCALE ID</li> <li>• DIFFERENCE</li> <li>• DATE TIME</li> <li>• INFO</li> <li>• MODE</li> <li>• NAME</li> <li>• LAYOUT</li> <li>• FORMAT</li> <li>• FEED</li> <li>• LIST</li> <li>• END PRINT2</li> </ul>	<ul style="list-style-type: none"> <li>• RESET</li> <li>• BAUD</li> <li>• PARITY</li> <li>• STOP BIT</li> <li>• HANDSHAKE</li> <li>• ALT. COMMAND</li> <li>• PRINT</li> <li>• TARE</li> <li>• ZERO</li> <li>• END COM1</li> </ul>	<ul style="list-style-type: none"> <li>• RESET</li> <li>• BAUD</li> <li>• PARITY</li> <li>• STOP</li> <li>• ADDRESS <sup>3)</sup></li> <li>• HANDSHAKE</li> <li>• ALT. COMMAND</li> <li>• PRINT</li> <li>• TARE</li> <li>• ZERO</li> <li>• END COM2</li> </ul>	<ul style="list-style-type: none"> <li>• RESET</li> <li>• EXT. INPUT</li> <li>• INPUT BEEP</li> <li>• RELAY OUTPUT</li> <li>• TYPE</li> <li>• SEQUENCE</li> <li>• CONTACT</li> <li>• STABLE</li> <li>• END I-O</li> </ul>	<ul style="list-style-type: none"> <li>• RESET</li> <li>• LOCK CAL</li> <li>• LOCK SETUP</li> <li>• LOCK READOUT</li> <li>• LOCK MODE</li> <li>• LOCK UNIT</li> <li>• LOCK PRINT1</li> <li>• LOCK PRINT2</li> <li>• LOCK COM1</li> <li>• LOCK COM2</li> <li>• LOCK GMP</li> <li>• LOCK I/O</li> <li>• END LOCK MENU</li> </ul>	<ul style="list-style-type: none"> <li>• RESET</li> <li>• LOCK ALL</li> <li>• LOCK OFF</li> <li>• LOCK ZERO</li> <li>• LOCK PRINT</li> <li>• LOCK UNIT</li> <li>• LOCK FUNCTION</li> <li>• LOCK MODE</li> <li>• LOCK TARE</li> <li>• LOCK MENU</li> <li>• END LOCK KEY</li> </ul>	

**Notes:**

- 1) Hidden when LEGAL FOR TRADE is ON.
- 2) Locked at current setting when LEGAL FOR TRADE is ON.
- 3) Visible only with RS485/RS422 option installed.



### 3.2 Menu Navigation

Enter the menu by pressing the **TARE Menu** button until MENU is displayed. When the button is released, the Legal for Trade status is displayed, followed by the first menu. Press the **No** or **Back** button to move to a different menu. Press the **Yes** button to enter the menu. Once in the menu, press the **Yes** button to view the menu item setting or press the **No** or **Back** button to move to the next menu item. When viewing the setting, press the **Yes** button to accept the setting, or press the **No** or **Back** button to change the setting. Once all settings have been made, press the **Exit** button to return to the current application mode.



For menu items with numeric settings such as Capacity, the current setting is displayed with all digits flashing. Press the **No** button to begin editing. The first digit is displayed flashing.

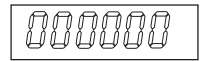

Press the **No** button to increment the digit or press the **Yes** button to accept the digit and move to the next digit.



Repeat this process for all digits.



Press the **Yes** button when the last digit has been set.



The new setting is displayed with all digits flashing. Press the **Yes** button to accept the setting or press the **No** button to resume editing.

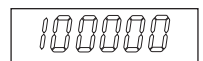

This method also applies to setting Checkweigh under and over targets.

For End menu items, pressing the **Yes** button advances to the next menu, while pressing the **No** button returns to the top of the current menu.

### 3.3 Calibration Menu



When CAL is displayed, press the **Yes** button to accept the Calibration menu selection. Press the **No** button to advance to the desired calibration menu item. Three calibration processes are available: Zero Calibration, Span Calibration and Linearity Calibration. Default settings are **bold**.

**NOTES:**

Zero	Perform
Span	Perform
Linearity	Perform
Cal Test	Perform
Geographic	
Adjustment	Set 00... <b>Set 12</b> ...Set 31
End Calibration	Exit CALIBRATE menu

1. Make sure that appropriate calibration masses are available before beginning calibration.
2. Make sure that the scale base is level and stable during the entire calibration process.
3. Calibration is unavailable with LFT set to ON.
4. Allow the Indicator to warm up for approximately 5 minutes after stabilizing to room temperature.
5. To abort calibration, press the **Exit** button anytime during the calibration process.
6. When any selection within the GMP menu is enabled, calibration results are automatically printed.

### 3.3.1 Zero Calibration

Zero calibration uses one calibration point. The zero calibration point is established with no weight on the scale. Use this calibration method to adjust for a different pre-load without affecting the span or linearity calibration. When ZER0 is displayed, press the **Yes** button to initiate Zero Calibration.



The display flashes 0 and the calibration unit. Press the **Yes** button to establish the zero point.



The display shows --C-- while the zero point is established.

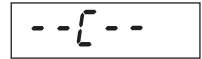

When zero calibration is completed, the display shows dONE.



Then the scale exits to the active weighing mode and displays the actual weight value.



### 3.3.2 Span Calibration

Span Calibration uses two points to adjust the scale. The span calibration point is established with a calibration mass placed on the scale. The zero calibration point is established with no weight on the scale.



When SPAN is displayed, press the **Yes** button to initiate Span Calibration.

The display flashes the span calibration point. Place the specified weight on the scale and press the **Yes** button.



To choose a different span point or calibration unit, edit the setting as explained in Section 3.2 Menu Navigation. When the desired setting is displayed, place the specified weight on the scale and press the **Yes** button.



The display shows --C-- while the span point is established.

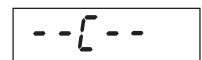

The display flashes 0.



With no weight on the scale, press the **Yes** button to establish the zero point.

The display shows --C-- while the zero point is established.

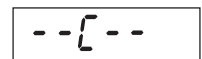

When span calibration is completed, the display shows dONE.



Then the scale exits to the active weighing mode and displays the actual weight value.



### 3.3.3 Linearity Calibration

Linearity calibration uses 3 calibration points. The full calibration point is established with a weight on the scale. The mid calibration point is established with a weight equal to half of the full calibration weight on the scale. The zero calibration point is established with no weight on the scale. The mid calibration points cannot be altered by the user during the calibration procedure.



When LINEAr is displayed, press the **Yes** button to initiate Linearity Calibration.

The display flashes the full calibration point and calibration unit. Place the specified weight on the scale and press the **Yes** button.



To choose a different full point or calibration unit (kg or lb), edit the setting as explained in Section 3.2 Menu Navigation. When the desired setting is displayed, place the specified weight on the scale and press the **Yes** button.

The display shows --C-- while the full point is established.

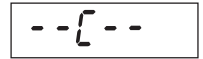

The display flashes the mid calibration point.

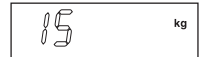

Place the specified weight on the scale and press the **Yes** button.

The display shows --C-- while the mid point is established.

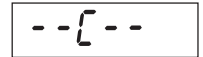

The display flashes 0.



With no weight on the scale, press the **Yes** button to establish the zero point.

The display shows --C-- while the zero point is established.

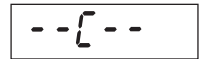

When linearity calibration is completed, the display shows dONE.



Then the scale exits to the active weighing mode and displays the actual weight value.



### 3.3.4 Calibration Test

Calibration test is used to compare a known calibration weight against the stored span calibration data.

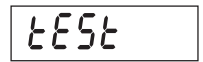

**NOTE:** Calibration Test is always available (even when LFT is set to ON).

When tEst is displayed, press the **Yes** button to initiate Calibration Test.

The display flashes 0. With no weight on the scale, press the **Yes** button to record the current zero point.



The display shows --t-- while the zero point is recorded.

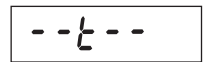

The display flashes the span calibration weight using the value from the last calibration. The example shows test weight of 30 kg.



Place the specified test weight on the scale and press the **Yes** button.

The display shows --t-- while the data is processed.

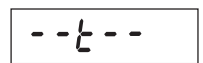

The display flashes the actual difference between the calibration data and the test weight.

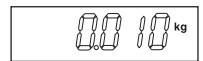

The example shows a 0.010 kg difference. The result of the Calibration Test is printed.

After 5 seconds, Calibration Test ends, the scale returns to the active weighing mode and displays the current weight.



### 3.3.5 Geographical Adjustment Factor

Refer to Table 3-2 and set the GEO factor that corresponds to your location.  
00 to 31



**NOTE:** Only an authorized manufacturer's representative or certified verification personnel may make these changes. Changing the geographical setting alters the calibration values.



### 3.3.6 End Calibration

Advance to the next menu.

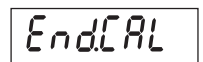

TABLE 3-2. GEOGRAPHICAL ADJUSTMENT VALUES

Geographical latitude away from the equator, (North or South) in degrees and minutes.	Elevation above sea level in meters										
	0	325	650	975	1300	1625	1950	2275	2600	2925	3250
	325	650	975	1300	1625	1950	2275	2600	2925	3250	3575
	Elevation above sea level in feet										
	0	1060	2130	3200	4260	5330	6400	7460	8530	9600	10660
	1060	2130	3200	4260	5330	6400	7460	8530	9600	10660	11730
0°00' - 5°46'	5	4	4	3	3	2	2	1	1	0	0
5°46' - 9°52'	5	5	4	4	3	3	2	2	1	1	0
9°52' - 12°44'	6	5	5	4	4	3	3	2	2	1	1
12°44' - 15°06'	6	6	5	5	4	4	3	3	2	2	1
15°06' - 17°10'	7	6	6	5	5	4	4	3	3	2	2
17°10' - 19°02'	7	7	6	6	5	5	4	4	3	3	2
19°02' - 20°45'	8	7	7	6	6	5	5	4	4	3	3
20°45' - 22°22'	8	8	7	7	6	6	5	5	4	4	3
22°22' - 23°54'	9	8	8	7	7	6	6	5	5	4	4
23°54' - 25°21'	9	9	8	8	7	7	6	6	5	5	4
25°21' - 26°45'	10	9	9	8	8	7	7	6	6	5	5
26°45' - 28°06'	10	10	9	9	8	8	7	7	6	6	5
28°06' - 29°25'	11	10	10	9	9	8	8	7	7	6	6
29°25' - 30°41'	11	11	10	10	9	9	8	8	7	7	6
30°41' - 31°56'	12	11	11	10	10	9	9	8	8	7	7
31°56' - 33°09'	12	12	11	11	10	10	9	9	8	8	7
33°09' - 34°21'	13	12	12	11	11	10	10	9	9	8	8
34°21' - 35°31'	13	13	12	12	11	11	10	10	9	9	8
35°31' - 36°41'	14	13	13	12	12	11	11	10	10	9	9
36°41' - 37°50'	14	14	13	13	12	12	11	11	10	10	9
37°50' - 38°58'	15	14	14	13	13	12	12	11	11	10	10
38°58' - 40°05'	15	15	14	14	13	13	12	12	11	11	10
40°05' - 41°12'	16	15	15	14	14	13	13	12	12	11	11
41°12' - 42°19'	16	16	15	15	14	14	13	13	12	12	11
42°19' - 43°26'	17	16	16	15	15	14	14	13	13	12	12
43°26' - 44°32'	17	17	16	16	15	15	14	14	13	13	12
44°32' - 45°38'	18	17	17	16	16	15	15	14	14	13	13
45°38' - 46°45'	18	18	17	17	16	16	15	15	14	14	13
46°45' - 47°51'	19	18	18	17	17	16	16	15	15	14	14
47°51' - 48°58'	19	19	18	18	17	17	16	16	15	15	14
48°58' - 50°06'	20	19	19	18	18	17	17	16	16	15	15
50°06' - 51°13'	20	20	19	19	18	18	17	17	16	16	15
51°13' - 52°22'	21	20	20	19	19	18	18	17	17	16	16
52°22' - 53°31'	21	21	20	20	19	19	18	18	17	17	16
53°31' - 54°41'	22	21	21	20	20	19	19	18	18	17	17
54°41' - 55°52'	22	22	21	21	20	20	19	19	18	18	17
55°52' - 57°04'	23	22	22	21	21	20	20	19	19	18	18
57°04' - 58°17'	23	23	22	22	21	21	20	20	19	19	18
58°17' - 59°32'	24	23	23	22	22	21	21	20	20	19	19
59°32' - 60°49'	24	24	23	23	22	22	21	21	20	20	19
60°49' - 62°09'	25	24	24	23	23	22	22	21	21	20	20
62°09' - 63°30'	25	25	24	24	23	23	22	22	21	21	20
63°30' - 64°55'	26	25	25	24	24	23	23	22	22	21	21
64°55' - 66°24'	26	26	25	25	24	24	23	23	22	22	21
66°24' - 67°57'	27	26	26	25	25	24	24	23	23	22	22
67°57' - 69°35'	27	27	26	26	25	25	24	24	23	23	22
69°35' - 71°21'	28	27	27	26	26	25	25	24	24	23	23
71°21' - 73°16'	28	28	27	27	26	26	25	25	24	24	23
73°16' - 75°24'	29	28	28	27	27	26	26	25	25	24	24
75°24' - 77°52'	29	29	28	28	27	27	26	26	25	25	24
77°52' - 80°56'	30	29	29	28	28	27	27	26	26	25	25
80°56' - 85°45'	30	30	29	29	28	28	27	27	26	26	25
85°45' - 90°00'	31	30	30	29	29	28	28	27	27	26	26

### 3.4 Setup Menu

SETUP

When the Indicator is used for the first time, enter this menu to set the Range, Capacity and Graduation. Default settings are **bold**.

Reset	<b>No</b> , Yes
Range	<b>Single</b> , Dual
Full Scale Capacity	<b>1</b> ...999950
Graduation	<b>0.00001</b> ...1000
Power On unit	<b>Auto</b> , kg, g, lb, oz, lb:oz
Zero Range	2%, <b>100%</b>
Auto-Tare	<b>Off</b> , On, Accept
Retain Weight Data	<b>Off</b> , On
Legal for Trade	<b>Off</b> , On
Beeper Volume	Off, <b>Lo</b> , Hi
Beeper Signal	<b>Off</b> , Accept, Under, Over, Under-Over
Button Beep	<b>Off</b> , On
End Setup	Exit SETUP menu

#### 3.4.1 Reset

Reset the Setup menu to the factory defaults. (except Range, Capacity and Graduation)

NO = not reset.

YES = reset.

rESEt

no

YES

**NOTE:** If the Legal for Trade menu item is set to ON, the Range, Capacity, Graduation, Zero Range, Auto Tare, Retain Weight Data and Legal For Trade settings are not reset.

#### 3.4.2 Range

Set the number of weighing ranges.

SINGLE = one weighing range from zero to full capacity.

dUAL = two weighing ranges, where range 1 is from zero to half capacity and range 2 is from half capacity to full capacity.

rANGE

SINGLE

dUAL

#### 3.4.3 Capacity

Set the scale capacity as explained in Section 3.2 Menu Navigation.

**NOTE:** If dUAL was selected in the rANGE menu item, the Capacity setting defines the Range 2 capacity. The Range 1 capacity is automatically defined as half of the Capacity setting. For example, if Capacity is set to 15, the Range 1 capacity becomes 7.5.

After the capacity is set, select the Primary Unit.

kg = the primary unit is kilograms

lb = the primary unit is pounds

CAP

CAP <sup>1000</sup>

0000 10 kg

0000 10 <sup>1000</sup>kg

0000 15 kg

0000 15 lb

0000 15 lb

### 3.4.4 Graduation

Set the scale readability.

0.00001, 0.00002, 0.00005, 0.0001, 0.0002, 0.0005, 0.001, 0.002, 0.005, 0.01, 0.02, 0.05, 0.1, 0.2, 0.5, 1, 2, 5, 10, 20, 50, 100, 200, 500, 1000.

**NOTE:** Graduation settings are limited to values from Capacity divided by 1000 to Capacity divided by 30000. Therefore, not all settings are available for each capacity.

**NOTE:** If dUAL was selected in the rANGE menu item, the Graduation setting defines the Range 1 graduation. The Range 2 graduation is automatically defined as one step greater than the Graduation setting. For example, if Graduation is set to 0.001, the Range 2 graduation becomes 0.002.

**NOTE:** Range 2 graduation is retained even under half capacity until the scale returns to zero.

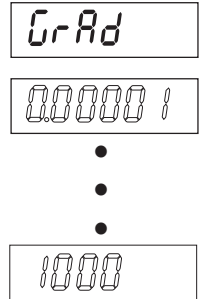

### 3.4.5 Power On Unit

Set the unit of measures displayed at startup

- AUTO = last unit in use when turned off
- PWr.UN kg = kilograms
- PWr.UN g = grams
- PWr.UN lb = pounds
- PWr.UN oz = ounces
- PWr.UN lb:oz = pound ounces
- PWr.UN t = tonnes
- PWr.UN C = custom unit

**NOTE:** Units oz, lb:oz and C (custom) will not be valid as Power On units when Range is set to Dual. The next available unit will be displayed instead

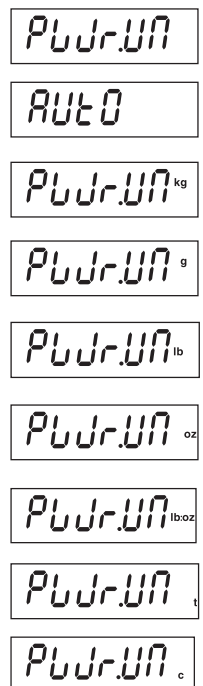

### 3.4.6 Zero Range

Set the percentage of scale capacity that may be zeroed.

- 2% = zero up to 2 percent of capacity
- 100% = zero up to full capacity



### 3.4.7 Auto-Tare

Set the Automatic Tare functionality.

- OFF = Automatic Tare is disabled.
- ON = the first stable gross weight will be tared.
- ACCEPT = when the application mode is CHECK, stable gross weight that is within the Checkweigh accept limits will be tared.

A-tArE

OFF

ON

ACCEPT

When Accept is selected, set the current delay time is displayed.

Settings:

- OFF = automatic tare takes affect immediately
- 0.5, 1, 2 or 5 = automatic tare takes affect after the selected delay period (in seconds).

OFF

0.5

1

2

5

### 3.4.8 Retain Weight Data

Set the Retain Weight Data functionality.

- OFF = Disabled.
- ON = When power is turned on, the displayed weight is based on the last stored zero (Zero button or "Z" command).

rEtArIn

OFF

ON

### 3.4.9 Legal for Trade

Set the legal for trade status.

- OFF = standard operation
- ON = operation complies with weights and measures regulations

LfT

OFF

ON

**NOTE:** When Legal for Trade is set to ON, the Menu settings are affected as follows:

- Calibration functions are hidden except for Calibration Test.
- Capacity is read-only.
- Range, Graduation, Power On unit, Auto-Tare, Retain Zero, Gross Indication, Print Output, Unit and Mode settings are locked at their current settings.
- Zero Range is locked at 2%.
- Stable Range is locked at 1d.
- Auto-Zero Tracking is set to 0.5d.
- Continuous Print is disabled.
- IP and CP RS232 commands are disabled.

**NOTE:** When Legal for Trade is set to ON, it is necessary to set the security switch to ON before exiting the menu. If the security switch is not set to ON, the message "NO.SW" is displayed and the indicator returns to the menu.



### 3.4.10 Beeper Volume

Set the beeper volume.

- OFF = disabled.
- LOW = soft
- HI = loud.

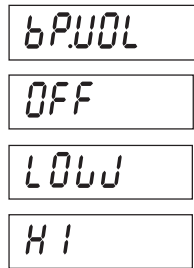

### 3.4.11 Beeper Signal

Set how the beeper responds in the Checkweigh mode.

- OFF = the beeper is disabled.
- ACCEPT = the beeper will sound when the weight is within the Accept range.
- UNdEr = the beeper will sound when the weight is below the Under setting.
- OVER = the beeper will sound when the weight is above the Over setting.
- UNd.Ovr = the beeper will sound when the weight is below the Under setting or above the Over setting.

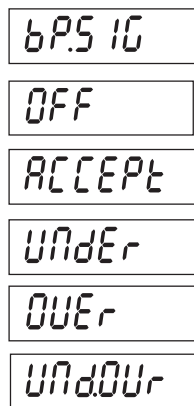

### 3.4.12 Button Beeper

Set how the beeper sounds when a button is pressed.

- OFF = no sound
- ON = sound

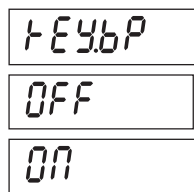

### 3.4.13 End Setup

Advance to the next menu.

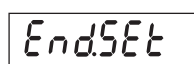

## 3.5 Readout Menu

Enter this menu to customize display functionality. Default settings are **bold**.

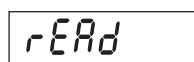

Reset	<b>No</b> , Yes
Stable Range	0.5d, <b>1d</b> , 2d, 5d
Filter Level	Lo, <b>Med</b> , Hi
Auto Zero Tracking	Off, <b>0.5d</b> , 1d, 3d
Backlight	Off, On, <b>Auto</b> (->Set 1, Set 2, Set 5)
Auto Off Timer	<b>Off</b> , Set 1, Set 2, Set 5
Gross Indicator	<b>Off</b> , Gross, Brutto
End Readout	Exit READOUT menu

**3.5.1 Reset**

Set the Readout menu to factory default settings.

NO = not reset

YES = reset

If the Legal for Trade menu item is set to ON, the Stable Range, Averaging Level, Auto Zero Tracking, Auto Off and Gross settings are not reset.

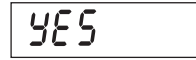

**3.5.2 Stable Range**

Set the amount the reading can vary before the stability symbol turns off.

0.5d = 0.5 scale division

1d = 1 scale division

2d = 2 scale divisions

3d = 3 scale divisions

5d = 5 scale divisions

**NOTE:** When LFT is set to ON, the setting is forced to 1 d. The setting is locked when the hardware lock switch is set to the ON position.

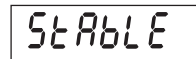

**3.5.3 Filter**

Set the amount of signal filtering.

LOW = less stability, faster stabilization time ( $\leq 1$  sec.)

MEd = normal stability, stabilization time ( $\leq 2$  sec.)

HI = greater stability, slower stabilization time ( $\leq 3$  sec.)



**3.5.4 Auto-Zero Tracking**

Set the automatic zero tracking functionality.

OFF = disabled.

0.5 d = the display will maintain zero until a change of 0.5 divisions per second has been exceeded.

1 d = the display will maintain zero until a change of 1 division per second has been exceeded.

3 d = the display will maintain zero until a change of 3 divisions per second has been exceeded.

**NOTE:** When the LFT menu item is set to ON, the selections are limited to 0.5d, 1d and 3d. The setting is locked when the hardware lock switch is set to the ON position.

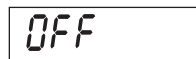
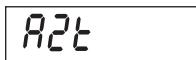

### 3.5.5 Backlight

Set the display backlight functionality.

- OFF = always off.
- ON = always on.
- AUTO = turns on when a button is pressed or the displayed weight changes.

When Auto is selected, set Backlight shut off time.

Settings:

- SEt 1 = backlight turns off after 1 minute of no activity.
- SEt 2 = backlight turns off after 2 minute of no activity.
- SEt 5 = backlight turns off after 5 minute of no activity.

LIGHT

OFF

ON

AUTO

SEt 1

SEt 2

SEt 5

### 3.5.6 Auto Off Timer

Set the automatic shut off functionality.

- OFF = disabled
- SEt 1 = powers off after 1 minute of no activity.
- SEt 2 = powers off after 2 minutes of no activity.
- SEt 5 = powers off after 5 minutes of no activity.

AOFF

OFF

SEt 1

SEt 2

SEt 5

### 3.5.7 Gross Indicator

Set the type of gross indicator.

- OFF = disabled
- G GrOSS = the G icon is lit when gross weights are displayed.
- B brutto = the B icon is lit when gross weights are displayed.

GROSS

OFF

GROSS

brutto

### 3.5.8 End Readout

Advance to the next menu.

Endrd

### 3.6 Mode Menu

Enter this menu to activate the desired application modes. Default settings are **bold**.

MODE

Reset	<b>No</b> , Yes
Weigh	Off, <b>On</b>
Count	<b>Off</b> , On (-> Piece weight optimization (-> On, Off))
Percent	<b>Off</b> , On
Dynamic	<b>Off</b> , Manual (-> Set 0 ... Set 60), Semi-automatic (-> Set 0 ... Set 60), Automatic (-> Set 0 ... Set 60)
Checkweigh	<b>Off</b> , On
End Mode	Exit MODE menu

**3.6.1 Reset**

Set the Mode menu to the factory defaults.

- NO = not reset.
- YES = reset.

**NOTE:** If the Legal for trade menu item is set ON, the settings are not reset.

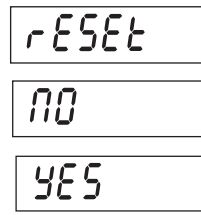

**3.6.2 Weighing Mode**

Set the status.

- OFF = Disabled
- ON = Enabled

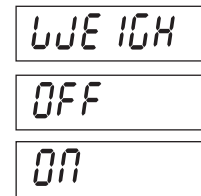

**3.6.3 Parts Counting Mode**

Set the status.

- OFF = Disabled
- ON = Enabled

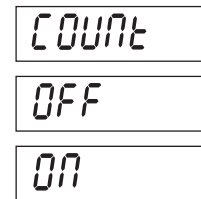

**3.6.4 Parts Counting Optimize**

Set the status.

- OFF = Disabled
- ON = Enabled

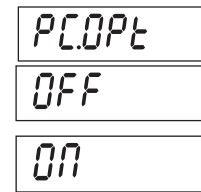

**3.6.5 Percent Weighing Mode**

Set the status.

- OFF = Disabled
- ON = Enabled

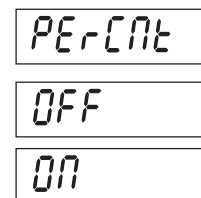

**3.6.6 Dynamic Weighing Mode**

Set the status.

- OFF = Disabled
- MAN = averaging and resetting are initiated manually by pressing the **FUNCTION** button.
- SEMI = averaging is automatically initiated when the load is greater than 5 divisions; resetting is manually initiated by pressing the **FUNCTION** button.
- AUTO = averaging is automatically initiated when the load is greater than 5 divisions; resetting is automatically initiated when the load is less than 5 divisions.

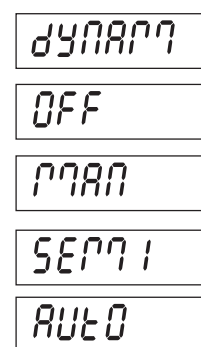

If MAN, SEMI or AUTO is selected, the current level setting is displayed.

Set the averaging time.

- SEt 0 = the first stable weight will be held on the display until it is reset (display hold).
- SEt 1 = the weight readings will be averaged for 1 second. The average will be held on the display until it is reset.
- SEt 60 = the weight readings will be averaged for 60 seconds. The average will be held on the display until it is reset.

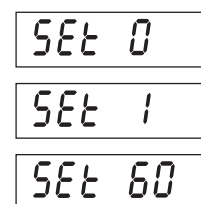

### 3.6.7 Check Weighing Mode

Set the status.

- OFF = Disabled
- ON = Enabled

CHECK

OFF

ON

### 3.6.8 End Mode

Advance to the next menu.

End Mode

### 3.7 Unit Menu

Enter this menu to activate the desired units. Default settings are **bold**.

UNIT

**Note:** Due to national laws, the indicator may not include some of the units of measure listed.

Reset	<b>No</b> , Yes
Kilograms	Off, <b>On</b>
Pounds	<b>Off</b> , On
Grams	<b>Off</b> , On
Ounces	<b>Off</b> , On
Pounds Ounces	<b>Off</b> , On
Tonnes	<b>Off</b> , On
Custom	<b>Off</b> , On (-> Factor, Exponent, LSD)
End Unit	Exit UNIT menu

#### 3.7.1 Reset

Set the Unit menu to the factory defaults.

- NO = not reset.
- YES = reset

**Note:** If the Legal for Trade menu item is set ON, the settings are not reset.

RESET

NO

YES

#### 3.7.2 Kilogram Unit

Set the status.

- OFF = Disabled
- ON = Enabled

UNIT <sup>kg</sup>

OFF

ON

#### 3.7.3 Pound Unit

Set the status.

- OFF = Disabled
- ON = Enabled

UNIT <sup>lb</sup>

OFF

ON

**3.7.4 Gram Unit**

Set the status.

- OFF = Disabled
- ON = Enabled

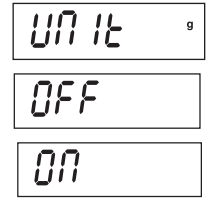

**3.7.5 Ounce Unit**

Set the status.

- OFF = Disabled
- ON = Enabled

**NOTE:** Ounce Unit is not available when Range is set to Dual.



**3.7.6 Pound Ounce Unit**

Set the status.

- OFF = Disabled
- ON = Enabled

**NOTE:** Pound Ounce Unit is not available when Range is set to Dual.



**3.7.7 Tonnes Unit**

Set the status.

- OFF = Disabled
- ON = Enabled



**3.7.8 Custom Unit**

Use Custom Unit to display weight in an alternative unit of measure. The custom unit is defined using a conversion factor, where the conversion factor is the number of custom units per kilogram expressed in scientific notation (Factor x 10^Exponent).

For example: To display weight in troy ounces (32.15075 troy ounces per kilogram) enter a Factor of 3.21508 and an Exponent of 1.

Set the status.

- OFF = Disabled
- ON = Enabled

**NOTE:** Custom Unit is not available when Range is set to Dual.



**Factor**

Set the conversion factor.

0.00001 to 9.99999

Refer to Section 3.2 Menu Navigation to enter settings.

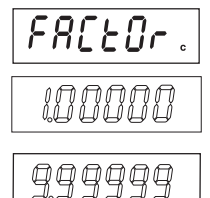

**Exponent**

Set the factor multiplier.

- 0 = 10<sup>0</sup> (Factor x 1)
- 1 = 10<sup>1</sup> (Factor x 10)
- 2 = 10<sup>2</sup> (Factor x 100)
- 3 = 10<sup>3</sup> (Factor x 1000)
- 2 = 10<sup>-2</sup> (Factor ÷ 100)
- 1 = 10<sup>-1</sup> (Factor ÷ 10)

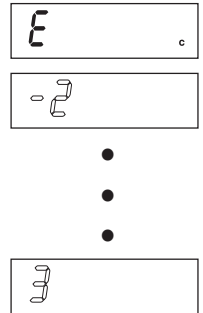

**Least Significant Digit**

Set the custom unit readability.

- 0.00001, 0.00002, 0.00005, 0.0001, 0.0002, 0.0005, 0.001, 0.002, 0.005, 0.01, 0.02, 0.05, 0.1, 0.2, 0.5, 1, 2, 5, 10, 20, 50, 100, 200, 500, 1000

**NOTE:** LSD settings are limited to values that result in a displayed resolution of 1000 to 30000 divisions.

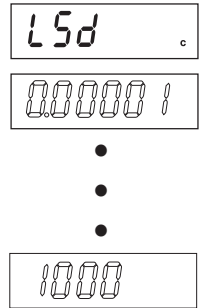

**3.7.9 End Unit**

Advance to the next menu.



**3.8 GMP Menu**

Enter this menu to set the data for Good Manufacturing Practice. Default settings are **bold**.



Reset	<b>No</b> , Yes
Date	Type (-> <b>MDY</b> , DMY, YMD) Set <b>00.00.00</b> ... 99.99.99
Time	Type (-> <b>24</b> hr, 12 hr) Set <b>HH:MM</b> or HH:MM A/P
User ID	<b>000000</b> ... 999999
Project ID	<b>000000</b> ... 999999
Scale ID	<b>000000</b> ... 999999
End GMP	Exit GMP menu

**3.8.1 Reset**

Set the GMP menu to factory defaults.

- NO = not reset.
- YES = reset.

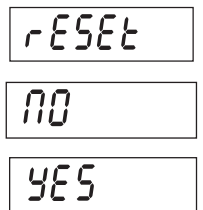

**3.8.2 Date Type**

Set the date format.

- MdY = Month.Day.Year
- dMY = Day.Month.Year
- YMd = Year.Month.Day



**3.8.3 Date Set**

Set the date.

- 00 to 99 = year position
- 01 to 12 = month position
- 01 to 31 = day position

Refer to Section 3.2 Menu Navigation to enter settings.

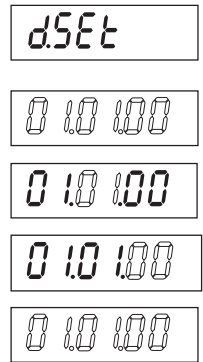

**3.8.4 Time Type**

Set the time format.

- 24 hr = 24 hour format.
- 12 hr = 12 hour format.

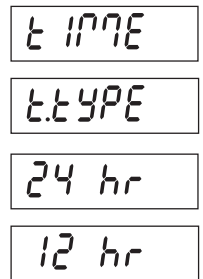

**3.8.5 Time Set**

Set the time.

24 hour format

- 00 to 23 = hour position
- 00 to 59 = minute position

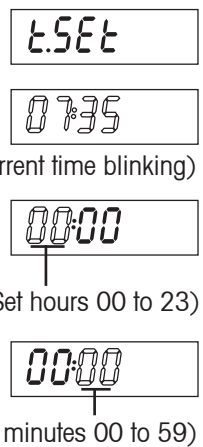

12 hour format

- 12 A to 12 P = hour position
- 00 to 59 = minute position

Refer to Section 3.2 Menu Navigation to enter settings.

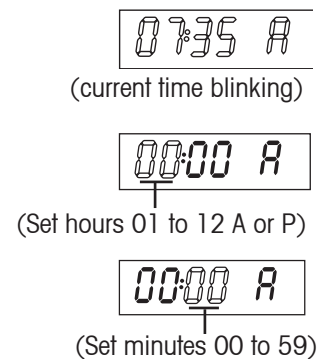



**3.8.6 User ID**

Set the user identification.  
000000 to 999999

Refer to Section 3.2 Menu Navigation to enter settings.

USER

000000

100000

200000

200000

2 10000

2 12345

2 12345

**3.8.7 Project ID**

Set the Project identification.  
000000 to 999999

Refer to Section 3.2 Menu Navigation to enter settings.

PrOJ

000000

**3.8.8 Scale ID**

Set the Scale identification.  
000000 to 999999

Refer to Section 3.2 Menu Navigation to enter settings.

SCALE

000000

**3.8.9 End GMP**

Advance to the next menu.

EndGMP

### 3.9 Print1 and Print2 Menus

Print 1

Print 2

Enter this menu to define printing parameters. Default settings are **bold**.

**NOTE:** The Print2 menu is only displayed if a second interface (RS232 or RS422/RS485) is installed.

#### 3.9.1 Reset

Set the Print menu to factory defaults.

- NO = not reset.
- YES = reset.

RESET

NO

YES

**NOTE:** If the Legal for Trade menu item is set to ON, the following settings are not reset: Stable

Reset	<b>No</b> , Yes
Stable Only	<b>Off</b> , On
Auto Print	<b>Off</b> , On Stable (-> Load, Load and Zero), Interval (-> 0...3600), Continuous, On Accept
Print Content	Result (-> Off, <b>On</b> , Numeric only), Gross (-> <b>Off</b> , On), Net (-> <b>Off</b> , On), Tare (-> <b>Off</b> , On), Header (-> <b>Off</b> , On), User ID (-> <b>Off</b> , On), Project ID (-> <b>Off</b> , On), Scale ID (-> <b>Off</b> , On), Difference (-> <b>Off</b> , On), Date and Time (-> <b>Off</b> , On), Information (-> <b>Off</b> , On), Application Mode ( <b>Off</b> , On), Name (-> <b>Off</b> , On),
Layout	Format (-> <b>Multiple</b> , Single), Feed (-> <b>Line feed</b> , 4 Line feed, Form feed)
List	<b>No</b> , Yes
End Print1	Exit PRINT1 menu
(End Print2)	Exit PRINT2 menu

#### 3.9.2 Print Stable Data Only

Set the print criteria.

- OFF = values are printed immediately.
- ON = values are only printed when the stability criteria are met.

STABLE

OFF

ON

#### 3.9.3 Auto Print

Set the automatic printing functionality.

- OFF = disabled.
- ON.StAb = printing occurs each time the stability criteria are met.
- INtEr = printing occurs at the defined interval.
- CONt = printing occurs continuously.
- ACCEPt = printing occurs each time the display is within the Checkweigh accept range and stability criteria are met.

APrint

OFF

ON.StAb

INtEr

CONt

ACCEPt

When ON.StAb is selected, set the condition for printing, where:

LOAD = prints when the load is stable and greater than zero

LOAD.Zr = prints when any load is stable and equal to or greater than zero.

LOAD

LOAD.Zr

When INtEr is selected, set the Print Interval.

1 to 3600 (seconds)

1

3600

### 3.9.4 Print Content Sub-menu

This sub-menu is used to define the content of the printed data.

#### Result

Set the status.

OFF = Disabled

ON = the displayed reading is printed.

NUM = only the numeric portion of the displayed reading is printed.

CONTENT

RESULT

OFF

ON

NUM

#### Gross

Set the status.

OFF = Disabled.

ON = the Gross weight is printed.

GROSS

OFF

ON

#### Net

Set the status.

OFF = Disabled.

ON = the Net weight is printed.

NET

OFF

ON

#### Tare

Set the status.

OFF = Disabled.

ON = the Tare weight is printed.

TARE

OFF

ON

#### Header

Set the status.

OFF = Disabled.

ON = the Header is printed.

HEADER

OFF

ON

#### User ID

Set the status.

OFF = Disabled.

ON = the User ID is printed.

USER

OFF

ON

**Project ID**

Set the status.

- OFF = Disabled.
- ON = the Project ID is printed.

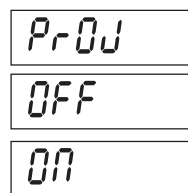

**Scale ID**

Set the status.

- OFF = Disabled.
- ON = the Scale ID is printed.

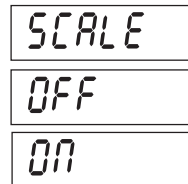

**Time**

Set the status.

- OFF = Disabled.
- ON = the Date and Time is printed.

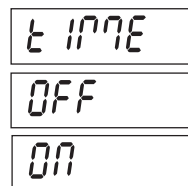

**Difference**

Set the status.

- OFF = Disabled.
- ON = the Calibration Test difference is printed.



**Reference Information**

Set the status.

- OFF = Disabled.
- ON = the Reference Information is printed.



**NOTE:** The Reference Information is dependent on the active mode (Weigh mode: None, Count mode: APW, Percent mode: Reference Weight, Dynamic mode: Level, Check Weigh mode: Under and Over limits).

**Mode**

Set the status.

- OFF = Disabled.
- ON = the Mode is printed.

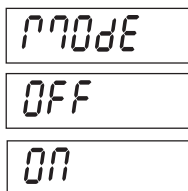

**Name**

Set the status.

- OFF = Disabled.
- ON = the Name line is printed.

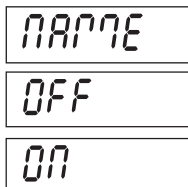

### 3.9.5 Layout Sub-menu

This sub-menu is used to define format of data output to a printer or computer.

LAYOUT

#### Format

Set the printing format.

- MULTI = a multi-line (single column style) printout is generated. A CRLF is added after each item.
- SINGLE = a single line printout is generated. (A TAB space is added between each item and a CLRF is used only after the very last item.)

FORMAT

MULTI

SINGLE

#### Line Feed

Set the paper feed.

- LINE = move paper up one line after printing
- 4.LINE = move paper up four lines after printing
- FORM = a form feed is appended to the printout

FEED

LINE

4LINE

FORM

### 3.9.6 Output

Set the format of the serial output string to a printer or computer.

OUTPUT

- DEF = use the default output format of the T51 indicator (see Section 5.2 Output Format).
- C11 = use the output format of the Ohaus CD/CW-11 indicators (see respective CD-11/CW-11 user manuals).

DEF

C11

### 3.9.7 List Menu Settings

Print the menu settings.

- NO = do not print.
- YES = print.

LIST

NO

YES

### 3.9.8 End Print1 or End Print2

Advance to the next menu.

EndPr1

EndPr2

### 3.10 COM1 and COM2 Menus

The table shows the items in the communication menus. Default settings are **bold**.

Enter the menu to define communication parameters.

COM1

COM2

**NOTE:** The COM2 menu is only displayed if a second interface (RS232 or RS422/RS485) is installed.

Reset	<b>No</b> , Yes
Baud Rate	300, 600, 1200, 2400, 4800, <b>9600</b> , 19200
Parity	7 Even, 7 Odd, 7 None, <b>8 None</b>
Stop Bit	<b>1</b> , 2
Handshake	<b>None</b> , XON/XOFF, Hardware
Address	<b>Off</b> , 01, ..., 99
Alt Command	Print (-> <b>Off</b> , A ... <b>P</b> ... Z), Tare (-> Off, A ... <b>T</b> ... Z), Zero (-> <b>Off</b> , A ... <b>Z</b> )
End Com1	Exit COM1 menu
(End Com2)	Exit COM2 menu

**3.10.1 Reset**

Set the COM1 and COM2 menu to factory defaults.

- NO = not reset.
- YES = reset.

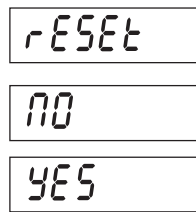

**3.10.2 Baud**

Set the Baud rate.

- 300 = 300 bps
- 600 = 600 bps
- 1200 = 1200 bps
- 2400 = 2400 bps
- 4800 = 4800 bps
- 9600 = 9600 bps
- 19200 = 19200 bps

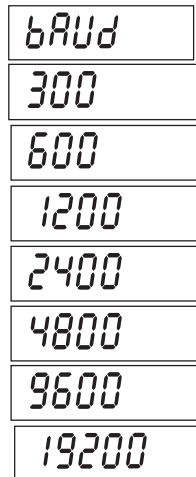

**3.10.3 Parity**

Set the data bits and parity.

- 7 EVEN = 7 data bits, even parity.
- 7 Odd = 7 data bits, odd parity.
- 7 NONE = 7 data bits, no parity.
- 8 NONE = 8 data bits, no parity.

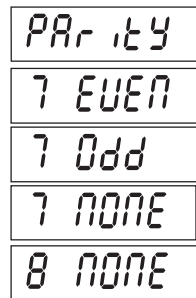

**3.10.4 Stop Bit**

Set the number of stop bits.

- 1 = 1 stop bit.
- 2 = 2 stop bits.

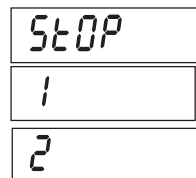

**3.10.5 Handshake**

Set the flow control method.

- NONE = no handshaking.
- ON-OFF = XON/XOFF software handshaking.
- HArd = hardware handshaking.



**3.10.6 Address**

Set the communication address.

**NOTE:** Address is only displayed in the COM2 menu if the RS422/RS485 option is installed.

- OFF = no address.
- 01 to 99 = address 01 to 99

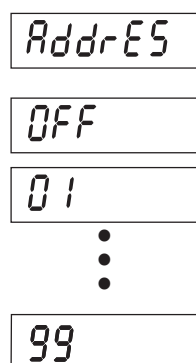

### 3.10.7 Alternate Command Sub-menu

Enter this sub-menu to set a different command character for the P (Print), T (Tare) and Z (Zero) commands.

ALtCP7

#### Alternate Print Command

Set the alternate command character for Print.  
A to Z.

ALtP

P

#### Alternate Tare

Set the alternate command character for Tare.  
A to Z.

ALtt

t

#### Alternate Zero

Set the alternate command character for Zero.  
A to Z.

ALtZ

Z

### 3.10.8 End COM1 or End COM2

Advance to the next menu.

EndC1

EndC2

### 3.11 I-O Menu

Enter this menu to set the optional input and output device parameters.  
Default settings are **bold**.

I-O

Reset	<b>No</b> , Yes
External Input	<b>Off</b> , Tare, Zero, Print, Function, Start-Stop, Tare-Start-Stop
Input Beep	Off, <b>On</b>
Relay Output	Type (-> Open, Closed), Sequence (-> Normal, Hold), Contact (-> Simultaneous, Break-Before-Make, Make-Before-Break) When Stable (-> Off, <b>On</b> )
End.I-O	Exit I-O menu

#### 3.11.1 Reset

Set the I-O menu to factory defaults

NO = not reset.

YES = reset.

rESEt

NO

YES

### 3.11.2 External Input

Set the function to be controlled by an optional external input device such as a foot switch.

- OFF = disabled.
- tArE = Tare function.
- ZErO = Zero function.
- PrINt = Print function.
- FUNcT = action specific to the current application mode.
- S-S = the first external input changes the state of the relay. The second external input (Start-Stop) returns the relay to the original state.
- t-S-S = the first external input initiates a Tare function, the second external input (Tare-Start-Stop) changes the state of the relay. The third external input returns the relay to its original state.

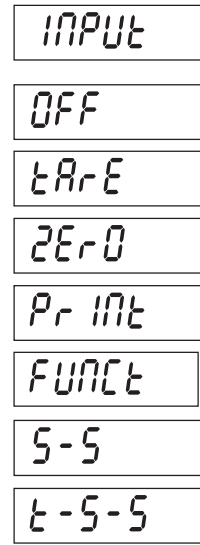

### 3.11.4 Input Beep

Set the beeper response to an external input.

- OFF = Disabled.
- ON = Enabled.



### 3.11.4 Relay Output

Set the relay output parameters.

**NOTE:** If the Relay option is not installed the OUTPUT menu and associated menu items are not available.

#### Type

Set the initial state of the relay.

- OPEN = the relay output is normally open.
- CLOSEd = the relay output is normally closed.



**CAUTION:** The normally closed relay condition is only active while the Indicator is powered on. When powered off or when power is removed, the relay condition returns to a normally open condition. Restoring power to the Indicator will restore the closed condition of the relays.

#### Output Sequence

Set how the relay outputs react as the weight reading changes from under / accept / over.

- NOrM = the previously enabled relay will be disabled as the next relay is enabled.
- HOLd = the previously enabled relay will hold the same state as the next relay is enabled.

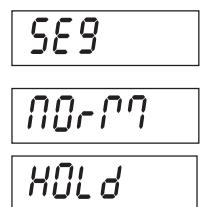



**Contact**

Set the timing of the relay contacts.

CONTACT

- SIM = relays open or close at the same time.
- b-b-M = relay opens before the next relay closes (break before make).
- M-b-b = relay closes before the next relay opens (make before break).

SIM

b-b-M

**NOTE:** A 100 ms delay or over-lap is used for the break-before-make and make-before-break timing.

M-b-b

**Stable**

Set how the relay outputs react during instability.

- OFF = relay changes are immediate.
- ON = delays relay changes until weight reading is stable.

STABLE

OFF

ON

**3.11.5 End I-O**

Advance to the next menu.

End I-O

**3.12 Menu Lock Menu**

Use this menu to prevent unauthorized changes to menu settings. When the security switch is set to ON, the locked menus can be viewed but not changed. Default settings are **bold**.

LMENU

Reset	<b>No</b> , Yes
Lock Calibration Menu	<b>Off</b> , On
Lock Setup Menu	<b>Off</b> , On
Lock Readout Menu	<b>Off</b> , On
Lock Mode Menu	<b>Off</b> , On
Lock Unit Menu	<b>Off</b> , On
Lock Print1 Menu	<b>Off</b> , On
Lock Print2 Menu	<b>Off</b> , On
Lock Com1 Menu	<b>Off</b> , On
Lock Com2 Menu	<b>Off</b> , On
Lock GMP Menu	<b>Off</b> , On
Lock I-O Menu	<b>Off</b> , On
End Lock Menu	

**3.12.1 Reset**

Set the menu Lock menu to factory defaults.

- NO = not reset.
- YES = reset.

RESET

NO

YES

**NOTE:** Settings for LFT controlled menu items are not reset.

**3.12.2 Lock Calibration**

Set the status.

- OFF = Calibration menu is not locked.
- ON = Calibration menu settings is locked.

LCAL

OFF

ON

**3.12.3 Lock Setup**

Set the status.

- OFF = Setup menu is not locked.
- ON = Setup menu is locked.

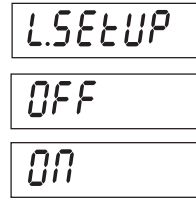

**3.12.4 Lock Readout**

Set the status.

- OFF = Readout menu is not locked.
- ON = Readout menu is locked.

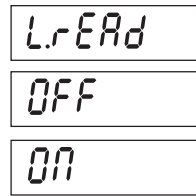

**3.12.5 Lock Mode**

Set the status.

- OFF = Mode menu is not locked.
- ON = Mode menu is locked.



**3.12.6 Lock Unit**

Set the status.

- OFF = Unit menu is not locked.
- ON = Unit menu is locked.



**3.12.7 Lock Print1**

Set the status.

- OFF = Print 1 menu is not locked.
- ON = Print 1 menu is locked.

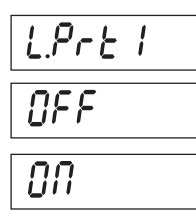

**3.12.8 Lock Print2**

Set the status.

- OFF = Print 2 menu is not locked.
- ON = Print 2 menu is locked.

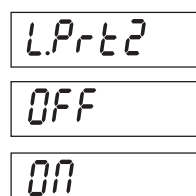

**3.12.9 Lock COM1**

Set the status.

- OFF = COM1 menu is not locked.
- ON = COM1 menu is locked.



**3.12.10 Lock COM2**

Set the status.

- OFF = COM2 menu is not locked.
- ON = COM2 menu is locked.

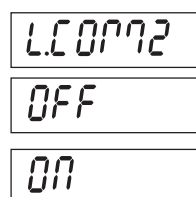

### 3.12.11 Lock GMP

Set the status.

- OFF = GMP menu is not locked.
- ON = GMP menu is locked.

L.GMP

OFF

ON

### 3.12.12 Lock I-O

Set the status.

- OFF = I-O menu is not locked.
- ON = I-O menu is locked.

L.I-O

OFF

ON

### 3.12.13 End Lock

Advance to the next menu.

EndLMP

## 3.13 Key Lock Menu

Use this menu to prevent unauthorized access to button functions. When the security switch is set to ON, the locked buttons are disabled. Default settings are **bold**.

LKEY

### 3.13.1 Reset

Set the Key lock menu to factory defaults.

- NO = not reset.
- YES = reset.

RESET

NO

YES

Reset	<b>No</b> , Yes
Lock All Buttons	<b>Off</b> , On
Lock Off Button	<b>Off</b> , On
Lock Zero Button	<b>Off</b> , On
Lock Print Button	<b>Off</b> , On
Lock Unit Button	<b>Off</b> , On
Lock Function Button	<b>Off</b> , On
Lock Mode Button	<b>Off</b> , On
Lock Tare Button	<b>Off</b> , On
Lock Menu Button	<b>Off</b> , On
End Lock Button	

### 3.13.2 Lock All Buttons

Set the status.

- OFF = all buttons unlocked.
- ON = all buttons are locked.

LALL

OFF

ON

### 3.13.3 Lock Off Button

Set the status.

- OFF = Off button is unlocked.
- ON = Off button is locked.

LOFF

OFF

ON

### 3.13.4 Lock Zero Button

Set the status.

- OFF = Zero button is unlocked.
- ON = Zero button is locked.

LZER0

OFF

ON

**3.13.5 Lock Print Button**

Set the status.

- OFF = Print button is unlocked.
- ON = Print button is locked.

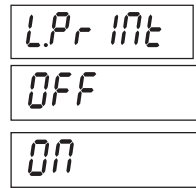

**3.13.6 Lock Unit Button**

Set the status.

- OFF = Unit button is unlocked.
- ON = Unit button is locked.



**3.13.7 Lock Function Button**

Set the status.

- OFF = Function button is unlocked.
- ON = Function button is locked.

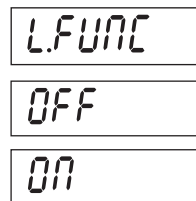

**3.13.8 Lock Mode Button**

Set the status.

- OFF = Mode button is unlocked.
- ON = Mode button is locked.



**3.13.9 Lock Tare Button**

Set the status.

- OFF = Tare button is unlocked.
- ON = Tare button is locked.

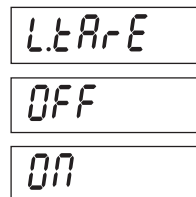

**3.13.10 Lock Menu Button**

Set the status.

- OFF = Menu button is unlocked.
- ON = Menu button is locked.

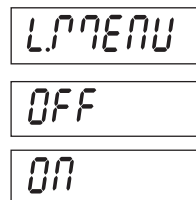

**NOTE:** When the Menu button is locked, the user may unlock this button by holding the Menu button for 10 seconds until UNLOCK is displayed. The hardware Lock Switch must be in the unlocked position.

**3.13.11 End Lock**

Advance to the next menu.



**3.14 Security Switch**

A slide switch is located on the Main PCB board. When the switch is set to the ON position, user menu settings that were locked in the Menu Lock and Key Lock menus can be viewed but not changed.

Open the housing as explained in Section 2.3.1. Set the position of security switch SW2 to ON as shown in Figure 1-3.

## 4. OPERATION

### 4.1 Turning Indicator On/Off

To turn the Indicator on, press the **ON/ZERO Off** button. The Indicator performs a display test followed by a series of informational displays, and then enters the active weighing mode.



To turn the Indicator off, press and hold the **ON/ZERO Off** button until OFF is displayed.

### 4.2 Zero Operation

Zero can be set under the following conditions:

- Automatically at Power On (initial zero).
- Semi-automatically (manually) by pressing the **ON/ZERO Off** button.
- Semi-automatically by sending the Zero command (Z or alternate zero command).



Press the **ON/ZERO Off** button to zero the weight display. The scale must be stable to accept zero operation.

### 4.3 Manual Tare

When weighing an item that must be held in a container, taring stores the container weight in memory.

Place the empty container on the scale (example 0.5 kg) and press the **TARE** button. The display will show the net weight.



To clear the Tare value, empty the scale and press the **TARE** button. The display will show the gross weight.



### 4.4 Pre-Set Tare

A Pre-set Tare (PT) is a known tare value entered using the xT command (example 1.234 kg).

The display will show the Pre-set Tare as a negative value, with the PT Indicator on.

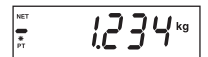

- NOTES:**
1. The PT value will supersede any other Tare or PT value in memory.
  2. When using Pre-Set Tare, make sure that Auto-Tare function is set off in the Setup menu.
  3. If the Tare entry includes digits beyond the readability of the Indicator, the tare value is rounded off to the readability of the Indicator.

To clear a Pre-set Tare value, empty the scale then press the **TARE** button. The display will show the Gross weight.

### 4.5 Auto-Tare

Auto-Tare automatically tares the initial weight (such as a container) placed on the empty scale, without having to press the **TARE** button. The tare value is cleared automatically when the weight on the scale is fully removed.

During Checkweighing operation, if the On Accept setting is selected in the Setup menu, weight values that are within the accept range will be tared automatically.

**NOTE:** Auto-Tare supersedes any pre-set (PT) value in memory.

### 4.6 Changing Units of Measure

Press and hold the **PRINT Units** button until the desired measuring unit appears. Only measuring units enabled in the Unit Menu will be displayed (refer to Section 3.7).

### 4.7 Printing Data

Printing the displayed data to a printer or sending the data to a computer requires that the communication parameters in the Print and Communication Menu are set (refer to Sections 3.9 and 3.10).

Press the **PRINT Units** button to send the displayed data to the communication port (the Auto-Print Mode in Section 3.9 function must be Off).

### 4.8 Application Modes

Press and hold the **FUNCTION Mode** button until the desired application mode appears. Only modes enabled in the mode menu will be displayed (refer to Section 3.6).

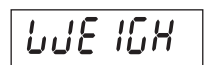

#### 4.8.1 Weighing

Place the item to be weighed on the scale. The illustration indicates a sample of 1.5 kg, Gross weight.

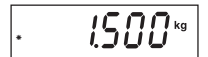

**NOTE:** Press the **FUNCTION Mode** button to temporarily display the weight in 10x expanded resolution.



#### 4.8.2 Parts Counting

Use this mode to count parts of uniform weight. The Indicator determines the quantity based on the average weight of a single part. All parts must be uniform in weight for accurate measurements.



#### Establishing the Average Piece Weight (APW)

When the **FUNCTION Mode** button is released, CLr.PW Pcs is displayed.

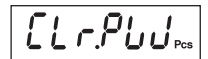

#### Clearing a Stored APW

Press the **Yes** button to clear the stored APW.

#### Recalling a Stored APW

Press the **No** button to recall the existing APW.

**NOTE:** Press the **FUNCTION Mode** button to temporarily display the APW value.

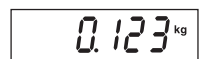
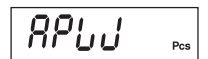

The display shows the sample size PUF 10Pcs.

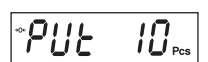

**Establishing a New APW**

Press the **No** button to increment the sample size. Choices are 5, 10, 20, 50 and 100.

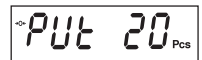

To establish the APW, place the specified quantity of samples on the scale and press the **FUNCTION Mode** button to capture the weight.

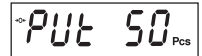

APW is displayed shortly followed by the APW value with the current unit of measure.

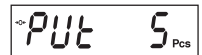
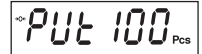

**Begin Counting**

Place the parts on the scale and read the count. If a container is used, be sure to tare the empty container first.

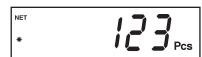
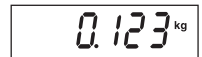

**4.8.3 Percent Weighing**

Use this mode to measure the weight of a sample as a percentage of a reference weight.

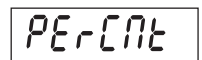

**Reference Weight (Ref Wt)**

When the **FUNCTION Mode** button is released, CLr.rEF% is displayed.

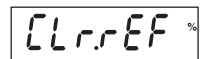

**Clearing a Stored Reference Weight**

Press the **Yes** button to clear the stored reference weight.

**Recalling a Stored Reference Weight**

Press the **No** button to recall the existing reference weight.

**NOTE:** Press the **FUNCTION Mode** button to temporarily display the reference weight.

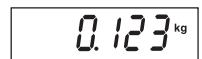

**Establishing a New Reference Weight**

The display shows Put.rEF %.

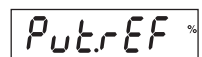

To establish the Ref Wt, place the sample on the scale and press the **FUNCTION Mode** button to capture the weight. rEF.Wt is displayed shortly followed by the REF Wt value with the current unit of measure.

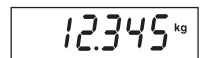

**Begin Percent Weighing**

Place the sample on the scale, and read the percent value. If a container is used, be sure to tare the empty container first.



### 4.8.4 Check Weighing

Use this mode to determine if the weight of a sample is within prescribed limits.



#### Checkweighing Limits

When the **FUNCTION Mode** button is released, CLr.rEF is displayed.



#### Clearing Stored Check Weighing Limits

Press the **Yes** button to clear the stored limits.

#### Recalling Stored Check Weighing Limits

Press the **No** button to recall the stored limits.

**NOTE:** Press the **FUNCTION Mode** button to temporarily display the Under and Over Limit values.



#### Editing the Under Setting

The display shows SEt.LO. Press the **Yes** button to edit setting..

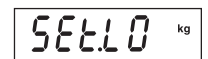

Settings:

-999950 to 999950

Refer to Menu Navigation Section 3.2 to enter settings.

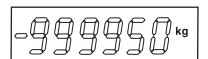

to

**NOTE:** The minus sign is used together with the first digit to show a negative value.

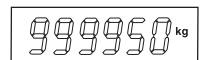

#### Editing the Over Setting

The display shows SEt.HI.

Press the **Yes** button to edit the Over setting.

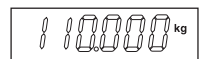

Settings:

-999950 to 999950

Refer to Menu Navigation Section 3.2 to enter settings.

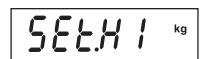

#### Begin Check Weighing

The appropriate Under, Accept or Over LED lights to indicate Check Weigh status.



Place a sample on the scale and read the weight.

For loads less than the Under Limit, the yellow Under LED is lit.



For loads greater than the Under Limit and less than the Over limit, the green Accept LED is lit.



For loads greater than the Over Limit, the red Over LED is lit.





### 4.8.5 Dynamic Weighing

Use this mode to weigh moving or oversized objects. The weight is held on the display until reset. Manual, semi-automatic and automatic start/stop methods are available (refer to Section 3.6.6).



#### Begin Dynamic Weighing

When the display shows rEAdY, place the object on the scale.

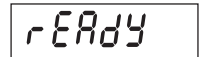

If the manual mode is in use, press the **FUNCTION Mode** button to start measurement. If the semi-automatic or automatic mode is in use, measurement is started automatically.

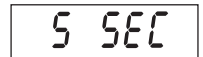

**NOTE:** When using manual mode, it is not necessary for the display to be at zero gross or net. When using semi-automatic or automatic mode, the display must be at zero gross or net before placing the object on the scale. The example is for a setting of 5 seconds. During the averaging period, the countdown timer decreases in one second increments.

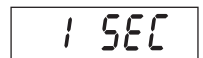

**NOTE:** If SET 0 was selected in the Dynamic menu item, the countdown timer is not displayed.

When the countdown has completed, the readings are averaged and held on the display. The averaged weight is displayed until reset.

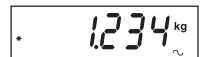

If the manual or semi-automatic mode is in use, reset the countdown timer by pressing the **FUNCTION Mode** button. Then the display shows rEAdY.

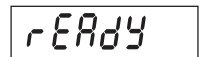
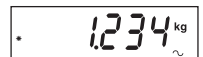

If the automatic mode is in use, the held reading is shown on the display for 10 seconds after the object is removed to within 5 divisions of zero. Then the display shows rEAdY.

The scale is now ready to accept a new object.

## 5. SERIAL COMMUNICATION

The T51P and T51XW Indicators include an RS232 serial communication interface.

The setup of RS232 operating parameters are more fully explained in Section 3.10. The physical hardware connection is explained in Section 2.6.

The interface enables display and GMP data to be sent to a computer or printer. A computer can be used to control some functions of the indicator using the commands listed in Table 5-1.

### 5.1 Interface Commands

Communicate to the indicator using the command characters listed in Table 5-1.

**TABLE 5-1. SERIAL INTERFACE COMMAND TABLE.**

Command Character <sup>1)</sup>	Function
IP	Immediate Print of displayed weight (stable or unstable).
P <sup>2)</sup>	Print displayed weight (stable or unstable).
CP	Continuous Print.
SP	Print on Stability.
xP	Interval Print x = Print Interval (1-3600 sec)
Z <sup>2)</sup>	Same as pressing Zero button
T <sup>2)</sup>	Same as pressing Tare button
xT	Enter a preset tare, where x = the tare value in grams.
PU	Print current unit: g, kg, lb, oz, lb:oz, t, C (custom)
xU	Set scale to unit x: 1=g, 2=kg, 3=lb, 4=oz, 5=lb:oz, 6=t, 7=C
PV	Version: print name, software revision and LFT ON (if LFT is set ON).
H x "text"	Enter Header line , where x = line number 1 to 5, "text" = header text up to 24 alphanumeric characters
Esc R	Global reset to reset all menu settings to the original factory defaults
xS <sup>4)</sup>	Print stable only. Where x=0 Off, x=1 On.
AS <sup>4)</sup>	Automatically send data when stable after motion.
xxxxS <sup>4)</sup>	Send at interval. Where xxxx=1 to 3600 seconds.
CS <sup>4)</sup>	Send as fast as possible (continuous print).
M <sup>4)</sup>	Increment to next enabled unit.
? <sup>4)</sup>	Print current unit: kg, g, lb, oz.

#### NOTES:

- 1) Commands sent to the Indicator must be terminated with a carriage return (CR) or carriage return-line feed (CRLF).
- 2) Alternate command characters may be defined by the user (see Alternate Commands in Section 3.10).
- 3) Data output by the Indicator is always terminated with a carriage return-line feed (CRLF).
- 4) These commands are only available when Print>Output is set to C11 (see Section 3.9.6).

### 5.2 Output Format

The default serial output format is shown below.

Field:	Weight	Space*	Unit	Space*	Stability	Space*	G/N	Space*	Term. Char(s)
Length:	9	1	5	1	1	1	N	1	**

\*Each field is followed by a single delimiting space (ASCII: 32)

Definitions:

Weight - up to 9 characters, right justified, "-" at immediate left of most significant character (if negative).

Unit - up to 5 characters

Stability - "?" character is printed if not stable. If weight is stable, neither "?" nor following space is printed.

G/N - "NET" printed if weight is net weight, "G", "B", or nothing (depending on GROSS menu setting - Sec. 3.5.7) printed if weight is a gross weight.

\*\*Terminating Character(s) - terminating character(s) printed depending on FEED menu setting (CR, LF / 4xCR, LF / ASCII: 12, refer also to Sec. 3.9.5.).

**NOTE:** If the Print Content – Result menu is set to Numeric Only, the Result output only includes the weight field and the termination characters.

### 5.3 Printouts

The following sample print outs are generated by the **Print** button, "P" Command or alternate print command. The content of the printout is defined in the Print Content menu item. A maximum of 24 characters can be printed on each line.

**NOTE:** Shaded areas = this date is printed when set on in the Print Content menu.

Unshaded = typical

#### Weigh Mode Printout

Ohaus Corporation
19A Chapin Road
P.O. Box 2033
Pine Brook, NJ, 07058 USA
Tel: +1-973-377-9000
01/31/08 12:30 PM
Scale ID: 123456
User ID: 123456
Project ID: 123456
Name: _____
10.00 kg NET
11.00 kg G
10.00 kg NET
1.00 kg T
Mode: Weigh

#### Count Mode Printout

Ohaus Corporation
19A Chapin Road
P.O. Box 2033
Pine Brook, NJ, 07058 USA
Tel: +1-973-377-9000
01/31/08 12:30 PM
Scale ID: 123456
User ID: 123456
Project ID: 123456
Name: _____
Quantity: 100 PCS
11.00 kg G
10.00 kg NET
1.00 kg T
APW 0.1000 kg
Mode: Count

#### Percent Mode Printout

Ohaus Corporation
19A Chapin Road
P.O. Box 2033
Pine Brook, NJ, 07058 USA
Tel: +1-973-377-9000
01/31/08 12:30 PM
Scale ID: 123456
User ID: 123456
Project ID: 123456
Name: _____
Percentage: 10 %
11.00 kg G
10.00 kg NET
1.00 kg T
Ref. Wt. 100.00 kg
Mode: Percent

**Dynamic Mode Printout**

Ohaus Corporation  
19A Chapin Road  
P.O. Box 2033  
Pine Brook, NJ, 07058 USA  
Tel: +1-973-377-9000  
01/31/08 12:30 PM  
Scale ID: 123456  
User ID: 123456  
Project ID: 123456  
Name: \_\_\_\_\_  
Final Wt.: 0.200 kg NET  
    12.34 kg G  
    11.11 kg NET  
    1.22 kg T  
Level: 10  
Mode: Dynamic

**Check Weighing Mode Printout**

Ohaus Corporation  
19A Chapin Road  
P.O. Box 2033  
Pine Brook, NJ, 07058 USA  
Tel: +1-973-377-9000  
01/31/08 12:30 PM  
Scale ID: 123456  
User ID: 123456  
Project ID: 123456  
Name: \_\_\_\_\_  
Result: 10.00 kg NET OVER  
    11.00 kg G  
    10.00 kg NET  
    1.00 kg T  
Under: 9.99 kg  
Over: 10.01 kg  
Mode: Checkweigh

**Calibration Test Printout**

----- Cal Test -----  
Ohaus Corporation  
19A Chapin Road  
P.O. Box 2033  
Pine Brook, NJ, 07058 USA  
Tel: +1-973-377-9000  
01/31/08 12:30 PM  
Scale ID: 123456  
User ID: 123456  
Project ID: 123456  
Name:-----  
Mode: Test  
New Cal: 10.000 kg  
Old Cal: 10.000 kg  
Diff: 0.000 kg  
Wt. ID:-----  
----- End -----

## 6. LEGAL FOR TRADE

When the indicator is used in trade or a legally controlled application it must be set up, verified and sealed in accordance with local weights and measures regulations. It is the responsibility of the purchaser to ensure that all pertinent legal requirements are met.

### 6.1 Settings

Before verification and sealing, perform the following steps:

1. Verify that the menu settings meet the local weights and measures regulations.
2. Perform a calibration as explained in Section 3.
3. Set Legal for Trade to ON in the Setup menu.
4. Without exiting the menu, turn the indicator off.
5. Disconnect power from the indicator and open the housing as explained in Section 2.3.1.
6. Set the position of the security switch SW2 to ON as shown in Figure 1-3, item 4.
7. Close the housing.
8. Reconnect power and turn the indicator on.

**NOTE:** When Legal for Trade is set to ON and the security switch is set to ON, the following menu settings cannot be changed: Zero Calibration, Span Calibration, Linearity Calibration, GEO, Range, Capacity, Graduation, Power On Unit, Zero Range, Auto Tare, Retain Weight, Legal for Trade, Stable Range, Auto Zero Tracking, Gross Indicator, Modes, Units, Stable Only.

### 6.2 Verification

The local weights and measures official or authorized service agent must perform the verification procedure.

### 6.3 Sealing

The local weights and measures official or authorized service agent must apply a security seal to prevent tampering with the settings. Refer to the illustrations below for sealing methods.

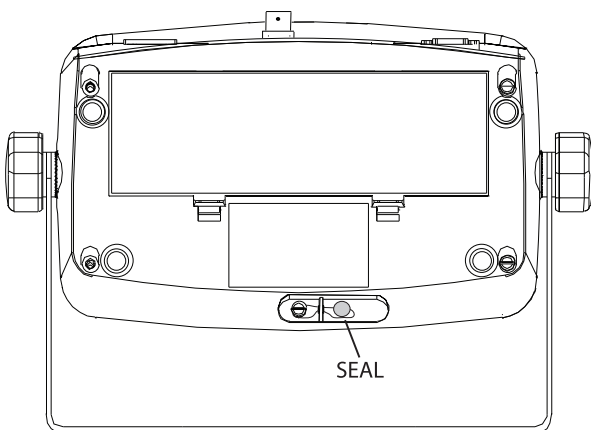

Figure 6-1. T51P Wire Seal

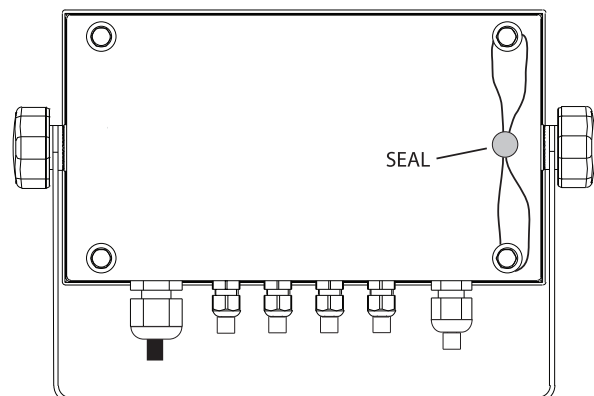

Figure 6-2. T51XW Wire Seal

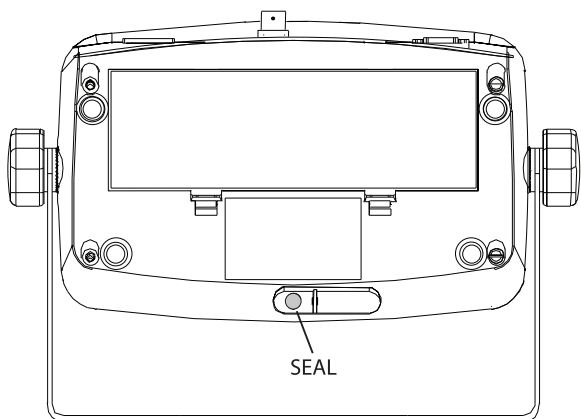

Figure 6-3. T51P Paper Seal

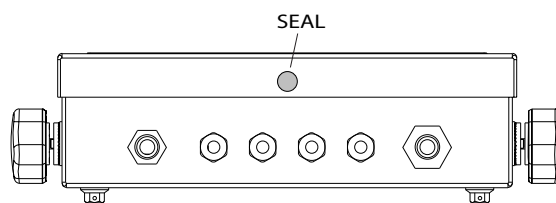

Figure 6-4. T51XW Paper Seal

When the scale base is attached to the indicator using a connector, it is necessary to seal the load cell cable to the indicator in some jurisdictions. The load cell sealing collar P/N 80500737 (Figure 6-5) is available as an accessory.

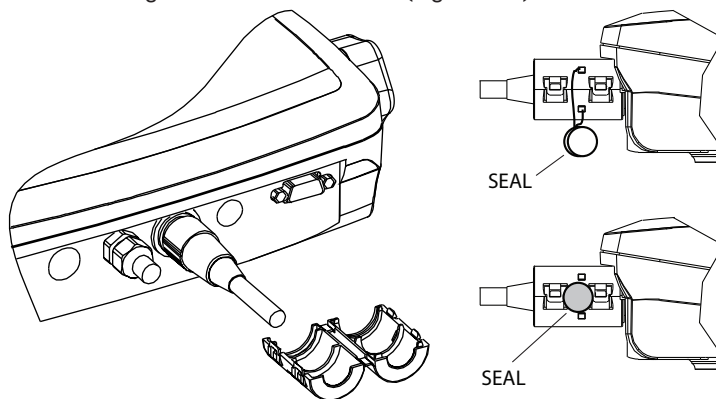

Figure 6-5. Load Cell Sealing Collar

## 7. MAINTENANCE

**CAUTION: DISCONNECT THE UNIT FROM THE POWER SUPPLY BEFORE CLEANING.**

### 7.1 Model T51P Cleaning

- The housing may be cleaned with a cloth dampened with a mild detergent if necessary.
- Do not use solvents, chemicals, alcohol, ammonia or abrasives to clean the housing or control panel.

### 7.2 Model T51XW Cleaning

- Use approved cleaning solutions for the stainless-steel Indicator housing and rinse with water. Dry thoroughly.
- Do not use solvents, chemicals, alcohol, ammonia or abrasives to clean the control panel.

### 7.3 Troubleshooting

**TABLE 7-1. TROUBLESHOOTING.**

SYMPTOM	PROBABLE CAUSE(S)	REMEDY
Unit will not turn on.	Power cord not plugged in or properly connected.  Power outlet not supplying electricity.  Battery discharged (T51P).  Other failure.	Check power cord connections. Make sure power cord is plugged in properly into the power outlet.  Check power source.  Replace batteries (T51P).  Service required.
Cannot zero the Scale, or will not zero when turned on.	Load on Scale exceeds allowable limits.  Load on Scale is not stable.  Load Cell damage.	Remove load on Scale.  Wait for load to become stable.  Service required.
Unable to calibrate.	Lock Calibration Menu set to On.  LFT menu set to On.  Incorrect value for calibration mass.	Set Lock Calibration Menu to Off. Refer to Section 3.12 Menu Lock.  Set LFT menu to Off.  Use correct calibration mass.
Cannot display weight in desired weighing unit.	Unit not set to On.	Enable unit in the Units Menu. Refer to Section 3.7 in the Unit Menu.
Cannot change menu settings.	Menu has been locked.	Set selected menu to Off in the Lock Menu. Lockout Switch on the circuit board may need to be set to the Off position.
Error 8.1	Weight reading exceeds Power On Zero limit.	Remove load from scale. Recalibrate scale.
Error 8.2	Weight reading below Power On Zero limit.	Add load to scale. Recalibrate scale.
Error 8.3	Weight reading exceeds Overload limit.	Reduce load on scale.
Error 8.4	Weight reading below Underload limit.	Add load to scale. Recalibrate scale.
Error 8.6	Weight exceeds six digits. Display overflow.	Reduce load on scale.

TABLE 7-1. TROUBLESHOOTING (Cont.).

SYMPTOM	PROBABLE CAUSE(s)	REMEDY
Error 9.5	Calibration data not present.	Calibrate scale.
Battery symbol flashing	Batteries are discharged.	Replace batteries (T51P).
CAL E	Calibration value outside allowable limits	Use correct calibration weight.
NO.SW	Attempting to exit the menu with the LFT setting ON and the security switch OFF.	Refer to Section 6.1. Set the security switch to the ON position.
REF WT Err	Reference Weight too small. The weight on the platform is too small to define a valid reference weight.	Use a greater weight for sample.

#### 7.4 Service Information

If the troubleshooting section does not resolve your problem, contact an authorized Ohaus Service Agent. For Service assistance in the United States, call toll-free 1-800-526-0659 between 8:00 AM and 5:00 PM Eastern Standard Time. An Ohaus Product Service Specialist will be available to assist you. Outside the USA, please visit our website [www.ohaus.com](http://www.ohaus.com) to locate the Ohaus office nearest you.



## 8. TECHNICAL DATA

### 8.1 Specifications

#### Materials

T51XW Housing: stainless-steel

T51P Housing: ABS plastic

Display window: polycarbonate

Keypad: polyester

Feet: Rubber

#### Ambient conditions

The technical data is valid under the following ambient conditions:

Ambient temperature: -10°C to 40°C / 14°F to 104°F

Relative humidity: Maximum relative humidity 80% for temperatures up to 31°C decreasing linearly to 50% relative humidity at 40°C.

Height above sea level: up to 2000m

Operability is assured at ambient temperatures between -10°C and 40°C.

**TABLE 8-1. SPECIFICATIONS**

Indicator	T51P	T51XW
Maximum Displayed Resolution	1:30,000	
Maximum Approved Resolution	1:10,000	
Maximum Counting Resolution	1:300,000	
Weighing Units	kg, lb, g, oz, lb:oz, tonnes, custom	
Functions	Static Weighing, Dynamic Weighing, Counting, Checkweighing, Percent Weighing	
Display	25 mm / 1 in High 6-digit, 7-segment LCD	
Over/Accept/Under Indicators	Red, Green, Yellow LED	
Backlight	White LED	
Keypad	4-button membrane switch	
Ingress Protection	---	IP66
Load Cell Excitation Voltage	5V DC	
Load Cell Drive	Up to 8 x 350 ohm Load Cells	
Load Cell Input Sensitivity	Up to 3 mV/V	
Stabilization Time	Within 2 Seconds	
Auto-zero Tracking	Off, 0.5, 1 or 3 Divisions	
Zeroing Range	2% or 100% of Capacity	
Span Calibration	1 kg or 1 lb to 100% Capacity	
Housing Dimensions (W x D x H) (mm/in)	260 x 71 X 168 / 10.2 x 2.7 x 6.6	262 x 76 x 149 / 10.3 x 3.0 x 5.8
Net Weight (kg/lb)	1.5 / 3.3	3.5 / 7.7
Shipping Weight (kg/lb)	2.3 / 5	4.3 / 9.5
Operating Temperature Range	-10°C to 40°C/14°F to 104°F	
Power	100-240 VAC / 50-60 Hz Internal Universal Power Supply, 6 C-type batteries (T51P)	
Interface	Built-in RS232 and External Input	

## 8.2 Accessories and Options

**TABLE 8-2. OPTIONS.**

DESCRIPTION	PART NUMBER
AC Relay Kit	80500720
Base Mount Kit, T51P	80500722
Column Mount Kit, 35 cm painted steel	80500723
Column Mount Kit, 68 cm painted steel	80500724
Column Mount Kit, 35 cm stainless steel	80500725
Column Mount Kit, 68 cm stainless steel	80500726
DC Relay Kit	80500727
Rechargeable Battery Kit	80500729
RS422/485 Interface Kit	80500731
RS232 Interface kit	80500733

**TABLE 8-3. ACCESSORIES.**

DESCRIPTION	PART NUMBER
Foot Switch	71173378
Interface Cable/PC 25-pin, T51P	80500524
Interface Cable/PC 9-pin, T51P	80500525
Interface Cable/PC 9-pin, T51XW	80500552
Interface Cable/PC 25-pin, T51XW	80500553
Load Cell Cable Adapter Kit	80500736
Load Cell Cable Sealing Collar	80500737



The Rechargeable Battery Kit, RS232 Kit, RS422/485 Kit, AC Relay Kit, DC Relay kit and Foot switch must be installed by a qualified technician.

8.3 Drawings and Dimensions

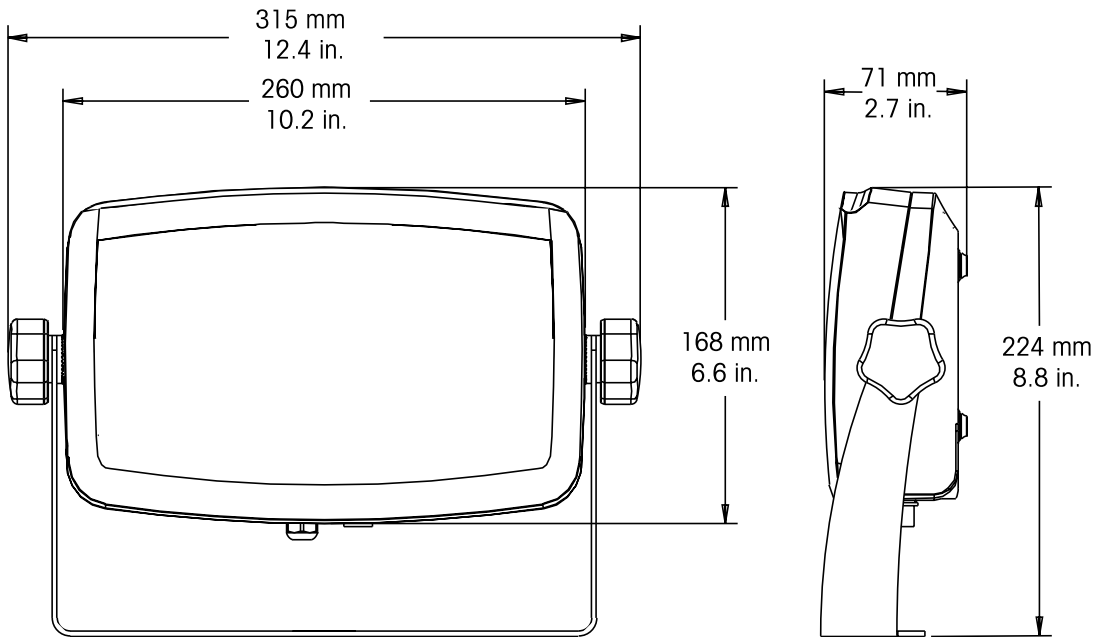

Figure 8-1. T51P Indicator Overall Dimensions with Mounting Bracket.

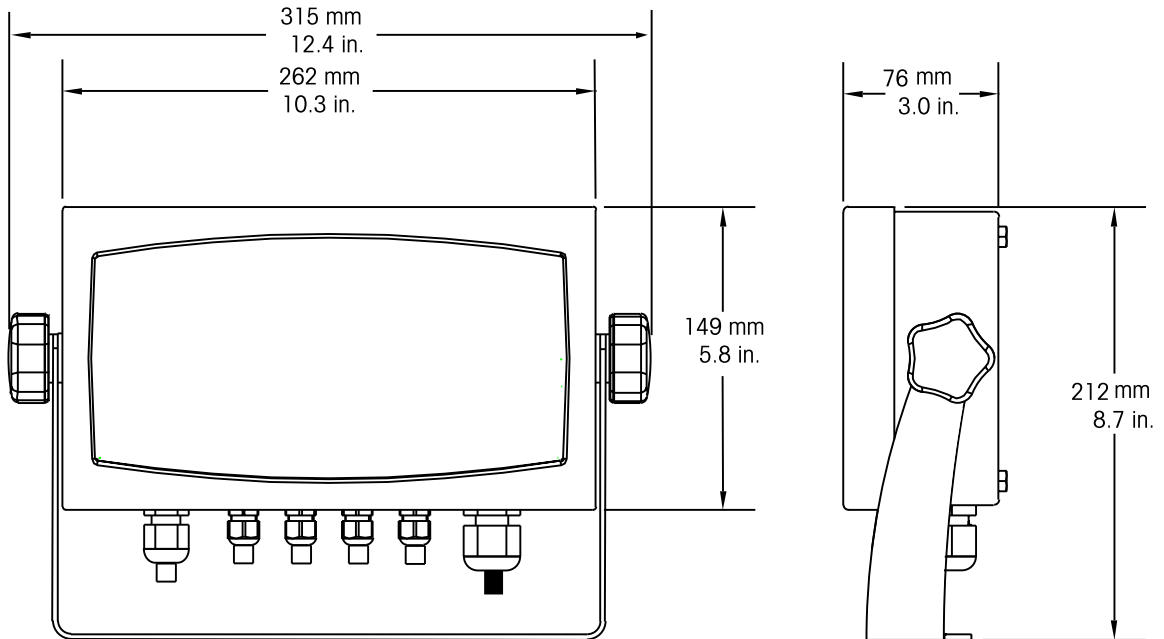





Figure 8-2. T51XW Indicator Overall Dimensions with Mounting Bracket.

## 8.4 Compliance

Compliance to the following standards is indicated by the corresponding marking on the product.

Marking	Standard
	This product conforms to the EMC Directive 2004/108/EC, the Low Voltage Directive 2006/95/EC and the Non-automatic Weighing Instruments Directive 2009/23/EC. The complete Declaration of Conformity is available from Ohaus Corporation.
	UL60950-1: 2003
	AS/NZS4251.1, AS/NZS4252.1

### EU Emissions Note

This device complies with EN55011 / CISPR 11 Class A Group 1.

### FCC Note

This equipment has been tested and found to comply with the limits for a Class A digital device, pursuant to Part 15 of the FCC Rules. These limits are designed to provide reasonable protection against harmful interference when the equipment is operated in a commercial environment. This equipment generates, uses, and can radiate radio frequency energy and, if not installed and used in accordance with the instruction manual, may cause harmful interference to radio communications. Operation of this equipment in a residential area is likely to cause harmful interference in which case the user will be required to correct the interference at his own expense.

### Industry Canada Note

This Class A digital apparatus complies with Canadian ICES-003.

Cet appareil numérique de la classe A est conforme à la norme NMB-003 du Canada.

### ISO 9001 Registration

In 1994, Ohaus Corporation, USA, was awarded a certificate of registration to ISO 9001 by Bureau Veritus Quality International (BVQI), confirming that the Ohaus quality management system is compliant with the ISO 9001 standard's requirements. On May 15, 2003, Ohaus Corporation, USA, was re-registered to the ISO 9001:2000 standard.

**Important Notice for verified weighing instruments**

Weighing Instruments verified at the place of manufacture bear one of the preceding marks on the packing label and the green 'M' (metrology) sticker on the descriptive plate. They may be put into service immediately.



Weighing Instruments to be verified in two stages have no green 'M' (metrology) on the descriptive plate and bear one of the preceding identification mark on the packing label. The second stage of the initial verification must be carried out by the approved service organization of the authorized representative within the EC or by the national weights & measures (W+M) authorities.

The first stage of the initial verification has been carried out at the manufacturer's work. It comprises all tests according to the adopted European standard EN 45501:1992, paragraph 8.2.2.

If national regulations limit the validity period of the verification, the user of the weighing instrument must strictly observe the re-verification period and inform the respective W+M authorities.

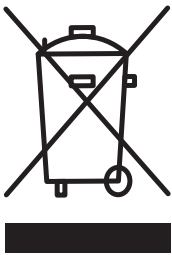
**Disposal**

In conformance with the European Directive 2002/96/EC on Waste Electrical and Electronic Equipment (WEEE) this device may not be disposed of in domestic waste. This also applies to countries outside the EU, per their specific requirements.

The Batteries Directive 2006/66/EC introduces new requirements from September 2008 on removability of batteries from waste equipment in EU Member States. To comply with this Directive, this device has been designed for safe removal of the batteries at end-of-life by a waste treatment facility.

Please dispose of this product in accordance with local regulations at the collecting point specified for electrical and electronic equipment.

If you have any questions, please contact the responsible authority or the distributor from which you purchased this device.

Should this device be passed on to other parties (for private or professional use), the content of this regulation must also be related.

For disposal instructions in Europe, refer to [www.ohaus.com/weee](http://www.ohaus.com/weee).

Thank you for your contribution to environmental protection.

## **LIMITED WARRANTY**

Ohaus products are warranted against defects in materials and workmanship from the date of delivery through the duration of the warranty period. During the warranty period Ohaus will repair, or, at its option, replace any component(s) that proves to be defective at No charge, provided that the product is returned, freight prepaid, to Ohaus.

This warranty does Not apply if the product has been damaged by accident or misuse, exposed to radioactive or corrosive materials, has foreign material penetrating to the inside of the product, or as a result of service or modification by other than Ohaus. In lieu of a properly returned warranty registration card, the warranty period shall begin on the date of shipment to the authorized dealer. No other express or implied warranty is given by Ohaus Corporation. Ohaus Corporation shall Not be liable for any consequential damages.

As warranty legislation differs from state to state and country to country, please contact Ohaus or your local Ohaus dealer for further details.





Ohaus Corporation  
19A Chapin Road  
P.O. Box 2033  
Pine Brook, NJ 07058, USA  
Tel: (973) 377-9000  
Fax: (973) 593-0359  
[www.ohaus.com](http://www.ohaus.com)



P/N 80251400 C © 2010 Ohaus Corporation, all rights reserved.

Printed in China